



FAX Option Type 2045



Operating Instructions Facsimile Reference <Advanced Features>



-
- 1 Transmission Mode
 - 2 Checking and Canceling Transmission Files
 - 3 Communication Information
 - 4 Other Transmission Features
 - 5 Reception Features
 - 6 LAN-Fax Features
 - 7 Simplifying the Operation
 - 8 Facsimile Features
 - 9 Key Operator Setting
 - 10 Solving Operation Problems
 - 11 Appendix

For safe and correct use of this machine, please be sure to read the Safety Information in the General Settings Guide before you use it.

Introduction

This manual describes detailed instructions on the operation and notes about the use of this machine. To get maximum versatility from this machine all operators are requested to read this manual carefully and follow the instructions. Please keep this manual in a handy place near the machine.

Notes

Some illustrations in this manual might be slightly different from the machine.

Certain options might not be available in some countries. For details, please contact your local dealer.

Two kinds of size notation are employed in this manual. With this machine refer to the metric version.

Important

Contents of this manual are subject to change without prior notice. In no event will the company be liable for direct, indirect, special, incidental, or consequential damages as a result of handling or operating the machine.

Trademarks

Microsoft®, Windows® and Windows NT® are registered trademarks of Microsoft Corporation in the United States and/or other countries.

Adobe® and Acrobat® are registered trademarks of Adobe Systems Incorporated.

Ethernet is a registered trademark of Xerox Corporation.

Other product names used herein are for identification purposes only and might be trademarks of their respective companies. We disclaim any and all rights in those marks.

Note

The proper names of the Windows operating systems are as follows:

- Microsoft® Windows® 95 operating system
- Microsoft® Windows® 98 operating system
- Microsoft® Windows® Millennium Edition (Windows Me)
- Microsoft® Windows® XP Professional
- Microsoft® Windows® XP Home Edition
- Microsoft® Windows® 2000 Server
- Microsoft® Windows® 2000 Professional
- Microsoft® Windows NT® Server operating system Version 4.0
- Microsoft® Windows NT® Workstation operating system Version 4.0

Manuals for This machine

The following manuals describe the operational procedures of this machine. For particular functions, see the relevant parts of the manual.

Note

- Manuals provided are specific to machine type.
- Adobe Acrobat Reader is necessary to view the manuals as a PDF file.
- Two CD-ROMs are provided:
 - CD-ROM 1"Operating Instructions for Printer/Scanner"
 - CD-ROM 2"Scanner Driver & Document Management Utilities"

❖ **General Settings Guide**

Provides an overview of the machine.

It also describes System Settings (such as paper trays and user codes settings), Document Server functions, and troubleshooting.

❖ **Network Guide (PDF file - CD-ROM1)**

Describes procedures for configuring the machine and computers in a network environment.

❖ **Copy Reference**

Describes operations, functions, and troubleshooting for the machine's copier function.

❖ **Facsimile Reference <Basic Features>**

Describes operations, functions, and troubleshooting for the machine's facsimile function.

❖ **Facsimile Reference <Advanced Features> (this manual)**

Describes advanced functions and settings for key operators.

❖ **Printer Reference 1**

Describes system settings and operations for the machine's printer function.

❖ **Printer Reference 2 (PDF file - CD-ROM1)**

Describes operations, functions, and troubleshooting for the machine's printer function.

❖ **Scanner Reference (PDF file - CD-ROM1)**

Describes operations, functions, and troubleshooting for the machine's scanner function.

❖ **Manuals for DeskTopBinder V2 Lite**

DeskTopBinder V2 Lite is a utility included on the CD-ROM labeled "Scanner Driver & Document Management Utilities".

- DeskTopBinder V2 Lite Setup Guide (PDF file - CD-ROM2)
Describes installation of, and the operating environment for DeskTopBinder V2 Lite in detail. This guide can be displayed from the **【Setup】** dialog box when DeskTopBinder V2 Lite is installed.
- DeskTopBinder V2 Lite Introduction Guide (PDF file - CD-ROM2)
Describes operations of DeskTopBinder V2 Lite and provides an overview of its functions. This guide is added to the **【Start】** menu when DeskTopBinder V2 Lite is installed.
- Auto Document Link Guide (PDF file - CD-ROM2)
Describes operations and functions of Auto Document Link installed with DeskTopBinder V2 Lite. This guide is added to the **【Start】** menu when DeskTopBinder V2 Lite is installed.

❖ **Manuals for ScanRouter V2 Lite**

ScanRouter V2 Lite Setup Guide (PDF file - CD-ROM2)

Describes installation of, settings, and the operating environment for ScanRouter V2 Lite in detail. This guide can be displayed from the **【Setup】** dialog box when ScanRouter V2 Lite is installed.

- ScanRouter V2 Lite Setup Guide (PDF file - CD-ROM2)
Describes installation of, settings, and the operating environment for ScanRouter V2 Lite in detail. This guide can be displayed from the **【Setup】** dialog box when ScanRouter V2 Lite is installed.
- ScanRouter V2 Lite Management Guide (PDF file - CD-ROM2)
Describes delivery server management and operations, and provides an overview of ScanRouter V2 Lite functions. This guide is added to the **【Start】** menu when ScanRouter V2 Lite is installed.

❖ **Other manuals**

- PS3 Supplement (PDF file - CD-ROM1)
- Unix Supplement (Available from an authorized dealer, or as a PDF file on our Web site.)

TABLE OF CONTENTS

Manuals for This machine.....	i
How to Read This Manual	1
Symbols	1
1. Transmission Mode	
<hr/>	
Sending at a Specific Time (Send Later)	3
User Transmission.....	5
Priority Transmission	6
Confidential Transmission.....	7
Polling Transmission.....	9
Polling Transmission Clear Report.....	11
Polling Reception.....	12
Polling Reserve Report	13
Polling Result Report	13
2. Checking and Canceling Transmission Files	
<hr/>	
Displaying Confirmation of Transmission.....	15
Canceling a Transmission	16
Deleting a Destination	17
Adding a Destination	18
Changing the Transmission Time	19
Printing a File	20
Resending a File	21
Printing a List of Files in Memory (Print TX File List).....	22
3. Communication Information	
<hr/>	
Printing the Journal	23
Journal	25
Checking the Transmission Result (TX File Status).....	27
Checking the Reception Result (RX File Status)	28
Displaying the Memory Status.....	29
Printing/Deleting Received and Stored Documents (Printing Stored RX File) ...	30
Printing Received and Stored Documents	30
Deleting Received and Stored Documents	31
Printing a Confidential Message	32
Confidential File Report.....	33
Printing a File Received with Memory Lock.....	34
Personal Boxes	36
Personal Boxes	36
Printing Personal Box Messages	36

Information Boxes	38
Information Boxes	38
Storing Messages in Information Boxes.....	38
Printing Information Box Messages	40
Deleting Information Box Messages	41

4. Other Transmission Features

Handy Dialing Functions.....	43
Chain Dial.....	43
(Example) 01133-1-555333.....	43
Redial.....	43
Advanced Features.....	45
SUB Code	45
SID Code	46
SEP Code	46
PWD Code.....	47
Transfer Request	48
With Transfer Requests set in the System Settings	50
On Hook Dial	51
Manual Dial.....	52
Changing the Line Port	53
Sub Transmission Mode	55
Book Fax.....	55
Two-Sided Transmission (Double-Sided Transmission).....	56
Standard Message Stamp.....	58
Sending an Auto Document	59
Printing documents stored as Auto Documents	60
Sending a Stored File.....	61
Sending stored documents.....	61
Printing stored documents.....	64
Stamp.....	66
Transmission Options	67
Fax Header Print	67
Label Insertion	68
Sender Stamp.....	68
Reduced Image Transmission.....	68
Auto Reduce.....	68
Default ID Transmission	69
Selecting transmission options for a single transmission	69
More Transmission Functions.....	71
If Memory Runs Out While Storing an Original	71
Parallel Memory Transmission.....	71
Checking the Transmission Result.....	72
Automatic Redial	72
Batch Transmission.....	72
ECM (Error Correction Mode)	72
Broadcasting Sequence	73
Checking the Transmission Progress	73
Dual Access	73

Transmission with Image Rotation	73
Simultaneous Broadcast	73
JBIG Transmission	74
Printed Report	75
Memory Storage Report	75
Transmission Result Report (Memory Transmission)	75
Communication Failure Report	75
Transmission Result Report (Immediate Transmission)	76

5. Reception Features

Reception.....	77
Immediate Reception	77
Memory Reception	77
Substitute Reception	79
Receiving messages unconditionally.....	79
Receiving messages according to parameter-specified settings.....	80
Reception Functions	81
Transfer Station.....	81
Transfer result report	82
JBIG Reception	82
Auto Fax Reception Power-up	83
Printing Options.....	84
Print Completion Beep	84
Checkered Mark.....	84
Center Mark	84
Reception Time	85
Two-Sided Printing.....	85
180-Degree Rotation Printing	86
Multi-copy Reception.....	86
Image Rotation.....	87
Combine Two Originals.....	87
Page Separation and Length Reduction	88
Reverse Order Printing	88
Page Reduction.....	89
TSI Print (Transmitting Subscriber Identification Print)	89
When There Is No Paper of the Correct Size.....	89
Just Size Printing.....	90
Setting Priority Trays	91
Having Incoming Messages Printed on Paper from the Bypass Tray	91
Where Incoming Message are Delivered - Output Tray.....	93
Specifying Tray for Lines.....	93
Tray Shift.....	93

6. LAN-Fax Features

Sending Fax Documents from Computers	95
Installing the Software	96
Auto Run Program	96
Installing Individual Applications	97
Applications Stored on the CD-ROM	97
LAN-Fax Driver	97
Address Book	98
LAN-Fax Cover Sheet Editor	98
Setting LAN-Fax Properties	98
Basic Transmission	99
Attaching a cover sheet	101
Previewing fax images	101
Specifying options	101
Printing or Saving as Files	103
Address Book	104
Editing Fax Cover Sheets	105
Creating a cover sheet	105
Attaching a created cover sheet	106
LAN-Fax Operation Messages	107
LAN-Fax Error Report	108
Error messages	108
Viewing Fax Information Using a Web Browser	109
Viewing and/or Printing Received Fax Messages Using a Web Browser	109
Viewing received fax messages using a Web browser	109
Printing fax information using a Web browser	110
Deleting fax information using a Web browser	110
Viewing Received Messages on a Computer	111
Delivering Received Messages	111

7. Simplifying the Operation

Programs	113
Registering and Changing Keystroke Programs	113
Registering a priority function using a program	114
Using a program	114
Changing a program name	115
Deleting a Program	116
Using the Document Server	117
Storing a Document	118
File Manage	120
Delete File	122
Managing Documents Saved in the Document Server from a Computer	123
Using DesktopBinder	123
Using a Web browser	123

8. Facsimile Features

Function List	125
Accessing User Tools (Facsimile Features)	129
Quitting Default Settings	129
General Settings/Adjustment	130
Reception Setting.....	132

9. Key Operator Setting

Key Operator Tools List	135
Using Key Operator Settings	137
Programming, Changing, and Deleting Standard Messages	137
Deleting Standard Messages	138
Storing, Changing, and Deleting an Auto Document	138
Deleting an Auto Document	140
Programming and Changing a Scan Size	140
Deleting a Scan Size	142
Printing the Journal	142
Counters.....	142
Forwarding	143
Programming an end receiver	144
Quitting the forwarding function.....	144
Forwarding mark.....	145
Memory Lock.....	145
ECM	146
Changing the User Parameters.....	147
Changing the User Parameters	151
Printing the User Parameter list.....	152
Special Senders to Treat Differently	152
Programming/Changing Special Senders	155
Programming Initial Set Up of a Special Sender	157
Deleting a Special Sender	159
Printing the Special Sender list.....	160
Box Settings	160
Programming/editing Personal Boxes	161
Deleting Personal Boxes	162
Programming/editing Information Boxes	163
Deleting Information Boxes	164
Programming/editing Transfer Boxes	165
Deleting Transfer Boxes	167
Printing the box list	168
Transfer Report	169
Programming a Confidential ID	170
Programming a Polling ID	170
Programming a Memory Lock ID	171
Selecting Dial/Push Phone.....	171
Storing or Printing Received Documents	172
Setting a User Code for Viewing Received and Stored Documents	173

10.Solving Operation Problems

Reading Reports	175
Error Report	175
Power Failure Report	175

11.Appendix

Replacing the Stamp Cartridge	177
Connecting the Machine to a Telephone Line and Telephone	178
Connecting the Telephone Line	178
Selecting the Line Type.....	178
Optional Equipment.....	179
Fax Function Upgrade Unit	179
Expansion Memory (32MB: DIMM)	179
Extra G3 Interface Unit	179
Specifications.....	180
Acceptable Types of Originals	181
Acceptable original sizes	181
Paper size and scanned area.....	181
Maximum Values.....	184
INDEX.....	186

How to Read This Manual

Symbols

In this manual, the following symbols are used:

 **WARNING:**

This symbol indicates a potentially hazardous situation that might result in death or serious injury when you misuse the machine without following the instructions under this symbol. Be sure to read the instructions, all of which are included in "Safety Information", *General Settings Guide*.

 **CAUTION:**

This symbol indicates a potentially hazardous situation that might result in minor or moderate injury or property damage that does not involve personal injury when you misuse the machine without following the instructions under this symbol. Be sure to read the instructions, all of which are included in "Safety Information", *General Settings Guide*.

* The statements above are notes for your safety.

 **Important**

If this instruction is not followed, paper might be misfed, originals might be damaged, or data might be lost. Be sure to read this.

 **Preparation**

This symbol indicates information or preparations required prior to operating.

 **Note**

This symbol indicates precautions for operation, or actions to take after abnormal operation.

 **Limitation**

This symbol indicates numerical limits, functions that cannot be used together, or conditions under which a particular function cannot be used.

 **Reference**

This symbol indicates a reference.

[]

Keys that appear on the machine's panel display.

[]

Keys and buttons that appear on the computer's display.

[]

Keys built into the machine's control panel.

1. Transmission Mode

Sending at a Specific Time (Send Later)

Using this function, you can instruct the machine to delay transmission of your fax message until a specified later time. This allows you to take advantage of off-peak telephone charges without having to be by the machine at the time.

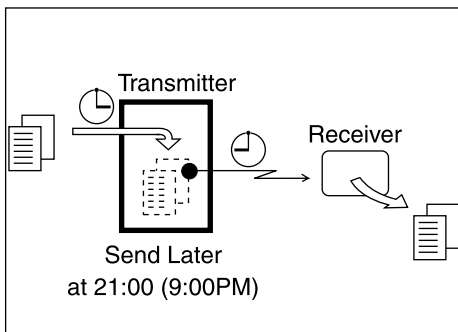

If you have a non-urgent fax, select Send Later with Economy Transmission when you scan it. Faxes will be queued in memory and sent during Economy Transmission Time.

Important

After the machine has been switched off for about one hour, all fax messages stored in memory are lost. If messages are lost for this reason, a Power Failure Report is automatically printed when the operation switch is turned on. Use this report to identify lost messages.

Limitation

This function is unavailable with Immediate Transmission. Use Memory Transmission.

Note

- You can specify a time within 24 hours.
- If the current time shown is not correct, change it. See the *General Settings Guide*.
- For convenience, you can program the time when your phone charges become cheaper as the Economy Transmission Time. See p.131 "Program Economy Time".
- You can program one of the Quick Operation keys with operations for this function. Using the key allows you to omit steps 2 and 3.

1 Place the original, and then select the scan settings you require.

Reference

p.11 "Placing Originals", *Facsimile Reference* <Basic Features>

p.27 "Scan Settings", *Facsimile Reference* <Basic Features>

2 Press [Transmission Mode].

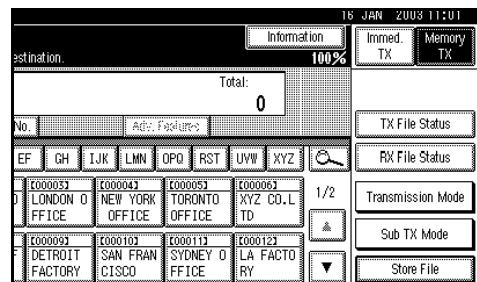

3 Select [Send Later].

- 4** Enter the time using the number keys (24 hr format), and then press [OK].

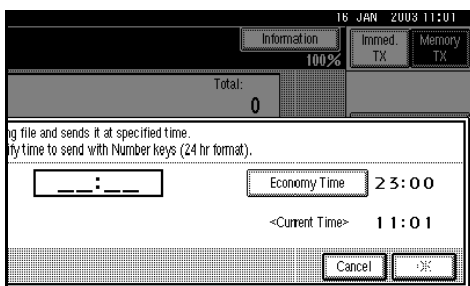

The specified time is shown above the highlighted [Send Later].

Note

- Press [Economy Time] to specify the economy time.
- When entering numbers smaller than 10, add a zero at the beginning.
- If you make a mistake, press [Clear] or the [Clear/Stop] key before pressing [OK], and then try again.
- To cancel Send Later, press [Cancel]. The display returns to that of step 3.

- 5** Press [OK].

The standby display appears.

Note

- To check the settings, press [Transmission Mode].

- 6** Dial and press the [Start] key.

Note

- You can cancel the transmission setup for Send Later. See p.16 "Canceling a Transmission".

User Transmission

This function allows you to check each user or department's transmission history. To use the function, you need to program a user code (eight digits max.) for each user or department, to be entered before transmission. See the *General Settings Guide*.

Note

- You can program codes of up to 8 digits for a maximum of 100 users and/or departments. With the optional account enhance module installed, you can program user codes for a maximum of 500 users and/or departments. See the *General Settings Guide*.
- You can enter user codes or names into various lists or reports.

- 1** Place the original, and then select desired scan settings.

Reference

p.27 "Scan Settings", *Facsimile Reference <Basic Features>*

- 2** Press [Transmission Mode].

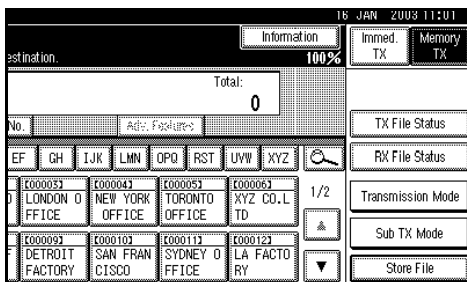

- 3** Press [User TX].

- 4** Using the number keys enter a user code (up to eight characters), and then press [#].

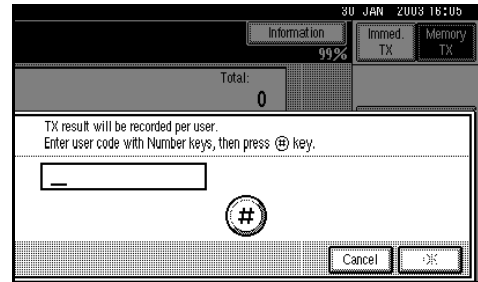

The programmed user name will appear.

Note

- If you enter a wrong code, press [Clear] or the [Clear/Stop] key before pressing [#], and then try again.
- To cancel the operation, press [Cancel]. The display returns to that of step 3.

- 5** Press [OK].

The standby display appears.

Note

- To check the settings, press [Transmission Mode].

- 6** Specify a destination, and then press the [Start] key.

Note

- You can cancel the transmission setup for User Transmission. See p.16 "Canceling a Transmission".

Priority Transmission

1

Documents you send with Memory Transmission are sent in the order they are scanned. Therefore, if several messages are queued in memory, the next document will not be sent immediately. However, by using this function you can have your message sent before other queued messages.

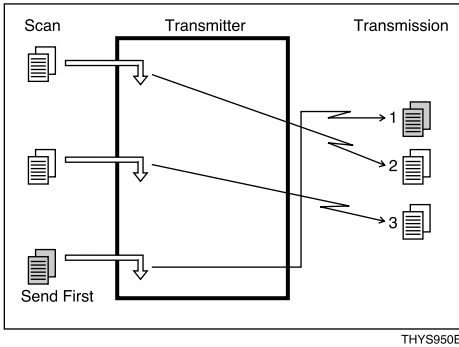

Limitation

- ❑ This function is not available with Immediate Transmission. If this function is selected, the machine automatically switches to Memory Transmission.

Note

- ❑ If there is already a message stored with this function or a transmission in progress, your message will be sent after that message has been transmitted.

- 1 Place the original, and then select the scan settings you require.

Reference

p.27 "Scan Settings", *Facsimile Reference* <Basic Features>

- 2 Press [Transmission Mode].

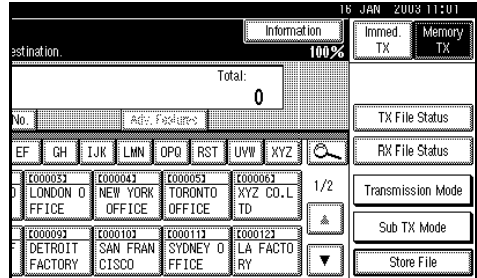

- 3 Select [Priority TX], and then press [OK].

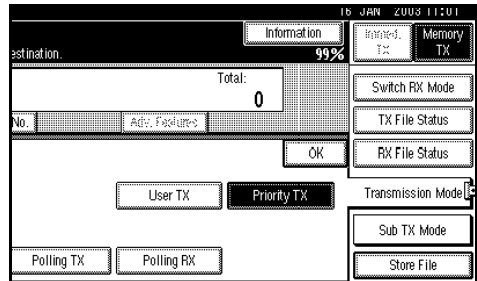

The standby display appears.

Note

- ❑ To check the settings, press [Transmission Mode].

- 4 Dial, and then press the [Start] key.

Note

- ❑ Press [Change/Stop TX File] to cancel the transmission.

Confidential Transmission

If you want to limit who views your message, use this function. The message will be stored in memory at the other end and not printed until an ID is entered.

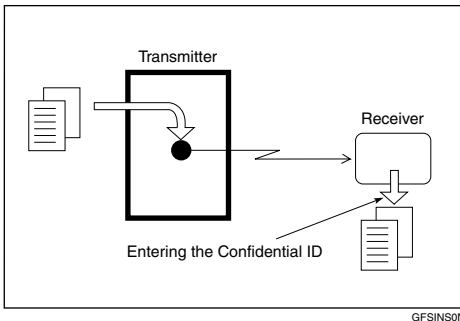

There are two types of Confidential Transmission:

❖ Default ID

It is not necessary to enter an ID when transmitting.

The other party can print the message by entering the Confidential ID programmed in their machine.

❖ ID Override

Should you want to send a confidential message to a particular person at the other end, you can specify the Confidential ID that the receiver has to enter to see that message. Before you send the message, do not forget to tell the receiver the ID that must be entered to print the message.

! Limitation

- ❑ The destination machine must be of the same manufacturer and have the Confidential Reception function.
- ❑ The destination machine must have enough memory available.

✎ Note

- ❑ We recommend that you program the Confidential ID beforehand. See p.170 "Programming a Confidential ID".
- ❑ An ID can be any 4-digit number (except 0000).
- ❑ If the destination machine is not of the same manufacturer, you can use Confidential Transmission with "SUB Code". See p.45 "SUB Code".

1 Place the original, and then select the scan settings you require.

🔍 Reference

p.11 "Placing Originals", *Facsimile Reference* <Basic Features>

p.27 "Scan Settings", *Facsimile Reference* <Basic Features>

2 Press [Transmission Mode].

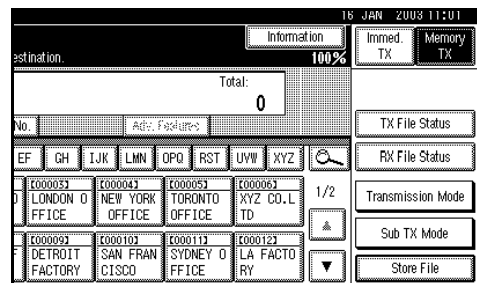

3 Select [Confidential TX].

1

4 Depending on the Confidential Transmission type, use one of the following procedures:

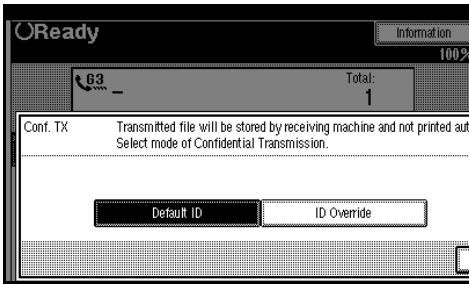

Default ID

- 1 Check that [Default ID] has been selected, and then press [OK].
"Default ID" is shown above the highlighted [Confidential TX].

Note

- To cancel Confidential Transmission, press [Cancel]. The display returns to that of step 3.

Override ID

- 1 Press [ID Override].
- 2 Enter the Confidential ID (4-digit number) using the number keys, and then press [OK].

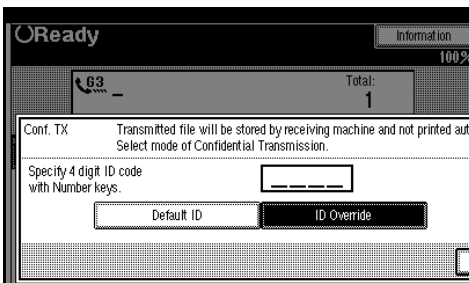

"ID Override" and the entered Confidential ID are shown above the highlighted [Confidential TX].

Note

- If you make a mistake, press [Clear] or the [Clear/Stop] key before pressing [OK], and then try again.
- To cancel Confidential Transmission, press [Cancel]. The display returns to that of step 3.

5 Press [OK].

Note

- To check the settings, press [Transmission Mode].

6 Dial, and then press the [Start] key.

Note

- You can cancel the transmission setup for Confidential Transmission. See p.16 "Canceling a Transmission".

Polling Transmission

Use Polling Transmission when you want to leave an original in the machine memory for others to pick up. The message will be sent when the other party calls you up.

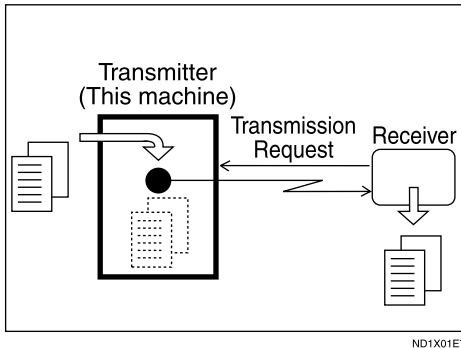

There are three types of Polling Transmission.

❖ Free Polling Transmission

It is not necessary to enter the Polling ID during the procedure. Anybody can poll the message from your machine. The machine sends it regardless of whether Polling ID's match.

❖ Default ID Transmission

It is not necessary to enter the Polling ID during the procedure. The message will only be sent if the Polling ID of the machine trying to poll your message is the same as the Polling ID stored in your machine. Make sure in advance that both machines' Polling IDs are identical.

❖ ID Override Transmission

You must enter an Override Polling ID unique to the transmission. This ID overrides the ID stored in the machine. The user must supply this ID when they poll your machine. If the IDs match, the message is sent. Make sure in advance the other end knows the ID you are using.

! Limitation

- Polling Transmission is allowed only if the receiver's machine has the Polling Reception function.
- Usually, only machines of the same manufacturer that support Polling Reception can perform ID Polling Transmission. However, when the Information Box File function is used, and the other party's fax machine supports Polling Transmission and the SEP function, you can still carry out Polling Transmission with an ID. See p.38 "Information Boxes".

📝 Note

- Free Polling and Default ID Transmission allow only one file to be stored in memory.
- ID Override Polling Transmission allows a file to be stored in memory for each ID; you can store up to 400 files (800 with the optional fax function upgrade unit) by changing IDs.
- Before using Default ID Transmission, you need to program the Polling ID. See p.170 "Programming a Polling ID".

- ❑ You can set whether a Polling Transmission file is deleted after transmitting in “User Parameters”. To save the file to transmit repeatedly, set to “Standby (Save)”. See p.147 “Changing the User Parameters” (switch 11, bit 7).
 - ❑ You can program one of the Quick Operation keys with operations for this function. Using the key allows you to omit steps 2 and 3.
 - ❑ The communication fee is charged to the receiver.
- 1** Place the original, and then select the scan settings you require.

Reference

p.11 “Placing Originals”, *Facsimile Reference* <Basic Features>
 p.27 “Scan Settings”, *Facsimile Reference* <Basic Features>

2 Press [Transmission Mode].

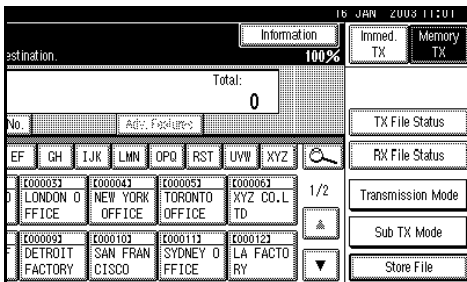

3 Select [Polling TX].

4 Depending on the Polling Transmission mode, use one of the following procedures:

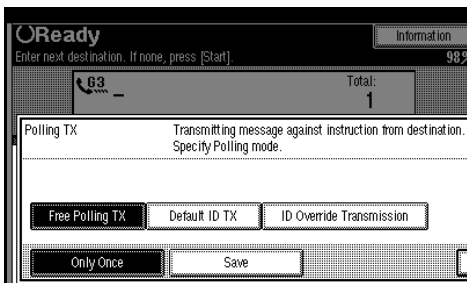

Free Polling Transmission

- 1** Check that [Free Polling TX] is selected.

Default ID Transmission

- 1** Select [Default ID TX].

ID Override Transmission

- 1** Select [ID Override Transmission].
- 2** Specify a 4-digit ID using the number keys and [A], [B], [C], [D], [E], and [F].

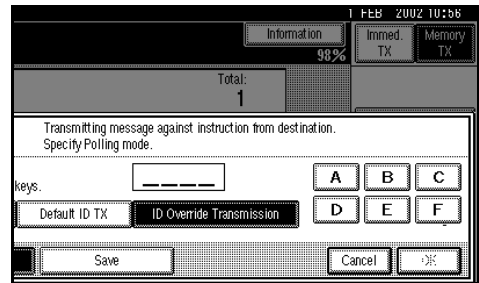

Note

- ❑ A Polling ID may be any four numbers (0 to 9) and characters (A to F), except 0000 and FFFF.
- ❑ If you make a mistake, press [Clear] or the [Clear/Stop] key, and then try again.

5 Press [Only Once] or [Save] to delete or save the file after transmission.

Note

- ❑ To delete the original immediately after transmission, select [Only Once].
- ❑ To repeatedly send the original, select [Save].
- ❑ To cancel Polling Transmission, press [Cancel]. The display returns to that of step 3.

6 Press [OK].
 “*****” appears.

The type of Polling Transmission is shown above the highlighted [Polling TX].

7 Press [OK].

 **Note**

- To check the settings, press [Transmission Mode].

8 Press the [Start] key.

 **Note**

- You can cancel the transmission setup for Polling Transmission. See p.16 “Canceling a Transmission”.

Polling Transmission Clear Report

This report allows you to verify whether Polling Transmission has taken place.

 **Limitation**

- This report is not printed if the User Parameters are set to allow the stored originals to be repeatedly sent (Save). See p.147 “Changing the User Parameters” (switch 11, bit 7).

 **Note**

- You can turn this function on or off with the User Parameters. See p.147 “Changing the User Parameters” (switch 03, bit 6).
- You can have a portion of the sent image printed on the report with the User Parameters. See p.147 “Changing the User Parameters” (switch 04, bit 7).
- You can check the result of Polling Transmission with the Journal. See p.23 “Printing the Journal”

Polling Reception

1

Use this function to poll a message from another terminal. You can also poll documents from many terminals with only one operation (use Groups and Keystroke Programs to fully exploit this function).

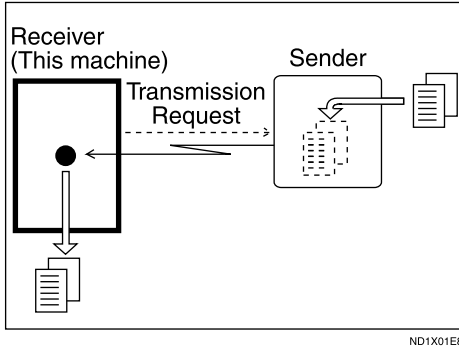

There are two types of Polling Reception.

❖ Default ID/Free Polling Reception

Use this method for Free Polling or Default ID Polling. If the Polling ID is programmed in your machine, any messages waiting in the transmitting machine with the same ID are received. If the other machine does not have any messages waiting with the same Polling ID, any messages that do not require ID are received (Free Polling).

❖ ID Override Polling Reception

You must enter an Override Polling ID unique to this transmission. This ID overrides the one stored in this machine.

Your machine will receive any messages waiting in the transmitting machine that have matching ID's. If no ID's match, any messages that do not require IDs are received (Free Polling).

📌 Limitation

- Polling Reception requires that the other machine is capable of Polling Transmission.
- Usually, you can only receive documents with a Polling ID from machines of the same manufacturer that support the polling function. However, if the other party's fax machine supports Polling Transmissions and the SEP function, and also has stored IDs, you can still perform Polling Reception. See p.46 "SEP Code".
- To receive a message sent by Default ID Polling Transmission or ID Override Polling Transmission, it is necessary to specify the same Polling ID as the sender's.
- To receive a message sent by Free Polling Transmission, it is not necessary to specify the same Polling ID as the sender's.

📌 Note

- For ID Polling Reception, program a Polling ID in advance. See p.170 "Programming a Polling ID".
- You can program one of the Quick Operation keys with operations for this function. Using the key allows you to omit steps 1 and 2.

1 Press [Transmission Mode].

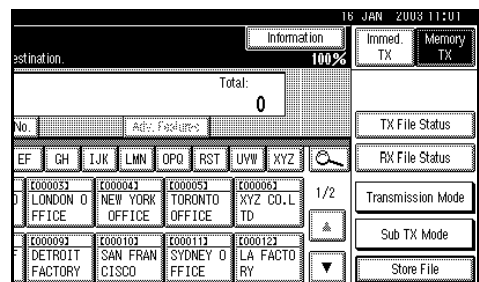

2 Select **[Polling RX]**.

3 Depending on which method you are using, select one of the following procedures:

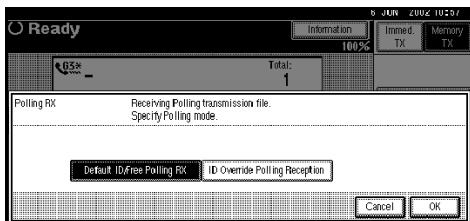

Default ID/Free Polling Reception

1 Check that **[Default ID/Free Polling RX]** is selected, and then press **[OK]**.

"Deflt ID/Free Poll." is shown above the highlighted **[Polling RX]**.

Note

- To cancel Polling Reception, press **[Cancel]**. The display returns to that of step **2**.

ID Override Polling Reception

1 Press **[ID Override Polling Reception]**.

2 Specify a 4-digit ID using the number keys and **[A]**, **[B]**, **[C]**, **[D]**, **[E]**, and **[F]**, and then press **[OK]**.

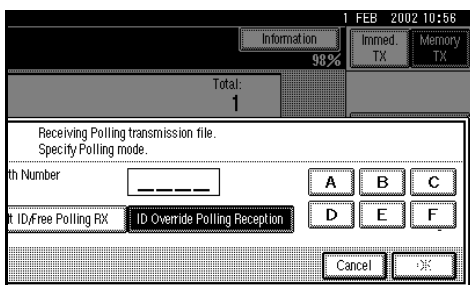

"ID Override" and the entered Polling ID are shown above the highlighted **[Polling RX]**.

Note

- A Polling ID may be any four numbers (0 to 9) and characters (A to F), except 0000 and FFFF.
- If you make a mistake, press **[Clear]** or the **[Clear/Stop]** key before pressing **[OK]**, and then try again.
- To cancel Polling Reception, press **[Cancel]**. The display returns to that of step **2**.

4 Press **[OK]**.

The standby display appears.

5 Dial, and then press the **[Start]** key.

Polling Reserve Report

This report is printed after Polling Reception has been set up.

Note

- You can turn this function on or off with the User Parameters. See p.147 "Changing the User Parameters" (switch 03, bit 3).

Polling Result Report

This report is printed after a Polling Reception has been completed and shows its result.

Note

- You can also check the result of a Polling Reception with the Journal. See p.23 "Printing the Journal".
- You can turn this function on or off with the User Parameters. See p.147 "Changing the User Parameters" (switch 03, bit 4).

2. Checking and Canceling Transmission Files

After you have pressed the **[Start]** key (after scanning originals), you can check and edit the destination or settings of Memory Transmission. You can also cancel a transmission, change the settings of a transmission, print a stored file, print a list of stored files, and resend a file which the machine failed to transmit.

This function is available for Memory Transmission, Confidential Transmission, Transfer Request, Polling Reception, and Polling Transmission.

Note

- If there are no files being sent, received, or stored by Memory Transmission, **[Change/Stop TX File]** does not appear on the display.
- You cannot check or edit a file being sent or received. Also a Confidential Transmission file or stored file to be printed as a report cannot be checked or edited.

Displaying Confirmation of Transmission

1 Press **[Change/Stop TX File]**.

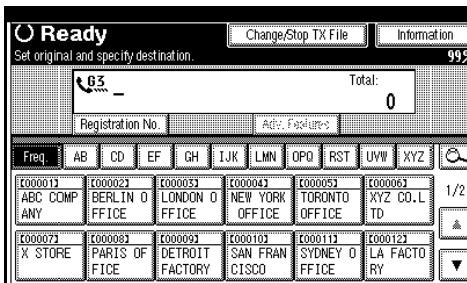

2 Select **[Check/Change Settings]**.

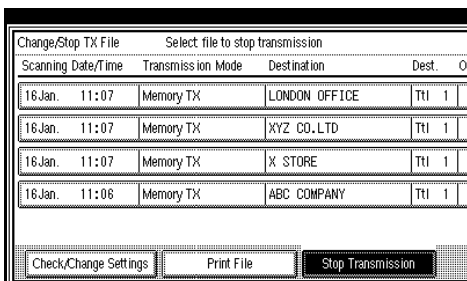

3 Select files to be changed or checked.

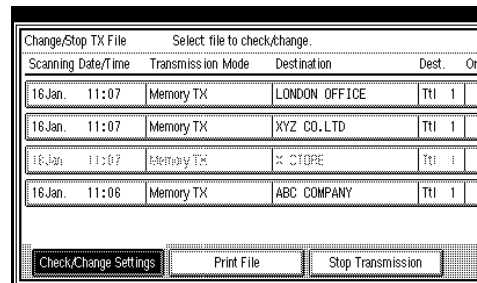

Note

- If multiple destinations were specified, only the destination selected first appears.
- If multiple destinations were specified, only the number of unsent messages appears.

4 Check a file, and then press **[Exit]**.

5 Press **[Exit]**.

The standby display appears.

Canceling a Transmission

You can cancel transmission of a file when the file is being sent, stored in memory, or fails to transmit. All the scanned data is deleted from memory.

2

You can cancel a file for Memory Transmission. This function is useful to cancel a transmission when you notice a mistake in destination or with the originals after storing. To cancel Memory Transmission, search for the file to be canceled among the files stored in memory, and then delete it.

Note

- If you cancel a transmission while the file is being sent, some pages of your file may have already been sent and will be received at the other end.
- If the transmission finishes while you are carrying out this procedure, transmission cannot be canceled.

1 Press [Change/Stop TX File].

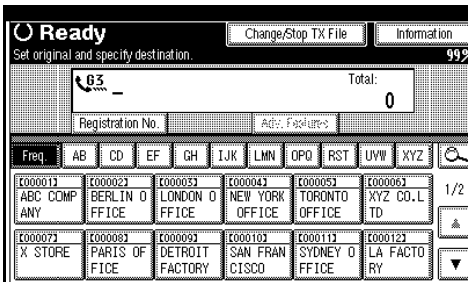

2 Select the files whose transmission you want to cancel.

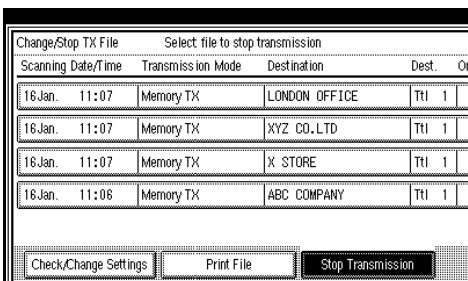

Note

- To display only the files being sent, press [Files under TX].
- If multiple destinations were specified, only the number of unsent messages appears.
- If multiple destinations were specified, only one destination number appears. To display all destinations, press [Check/Change Settings].

3 Press [Stop Transmission].

The selected file is deleted.

Note

- To quit transmission cancel, press [Save].
- To cancel another transmission, repeat from step 2.

4 Press [Exit].

The standby display appears.

Deleting a Destination

You can delete destinations.

Note

- ❑ If you delete a destination that is the only destination for a transmission, the transmission is canceled.

1 Press [Change/Stop TX File].

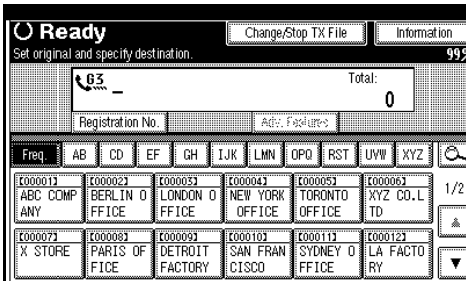

2 Press [Check/Change Settings].

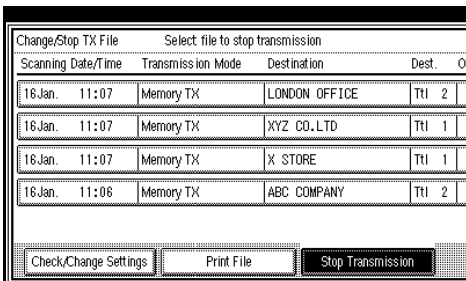

3 Select the file from which you want to delete a destination.

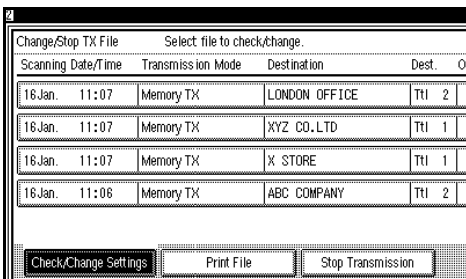

4 Press [Change] for the destination you want to delete.

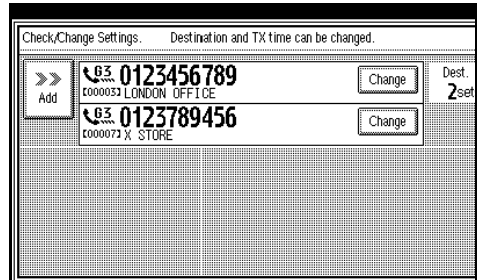

5 Press [Clear] to delete the destination.

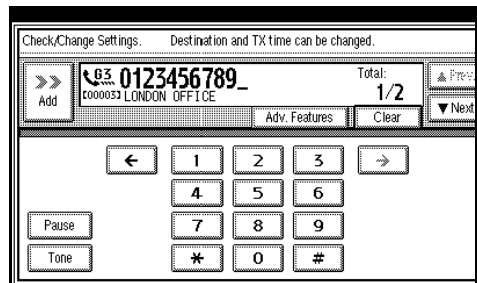

6 Press [Exit].

Note

- ❑ To delete another destination, repeat from step 3.

7 Press [Exit].

The standby display appears.

2

Adding a Destination

1 Press [Change/Stop TX File].

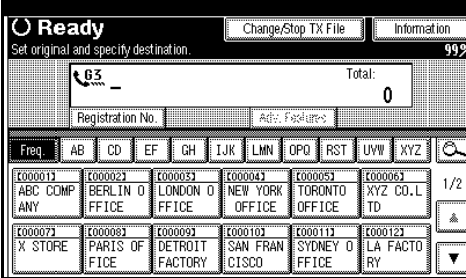

2 Press [Check/Change Settings].

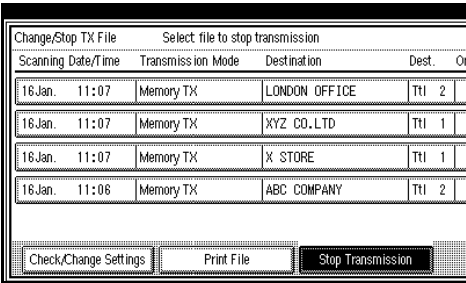

3 Select the file to which you want to add a destination.

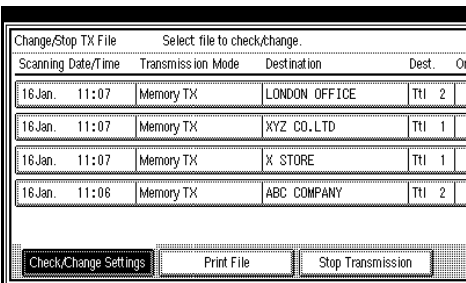

4 Press [Add].

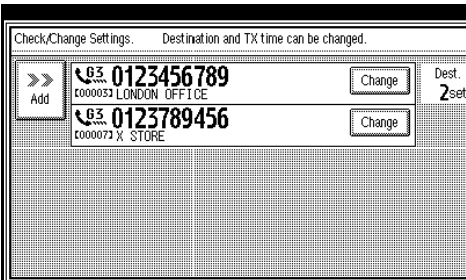

5 Specify the destination.

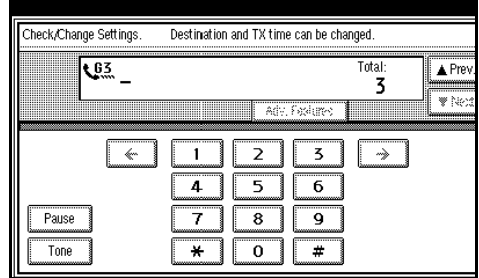

Note

- You can specify the destination using the number keys or soft (on-screen) keys.
- You can also program a SUB code and Sub-address by pressing [Adv. Features].

6 Press [Exit].

Note

- Repeat steps **4** and **5**, if you want to add another destination.

7 Press [Exit].

The standby display appears.

Changing the Transmission Time

You can change the transmission time specified with Send Later. See p.3 “Sending at a Specific Time (Send Later)”.

You can also delete the transmission time. If the transmission time is deleted, the file is transmitted immediately.

1 Press [Change/Stop TX File].

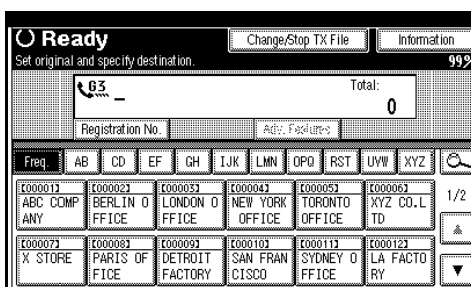

2 Press [Check/Change Settings].

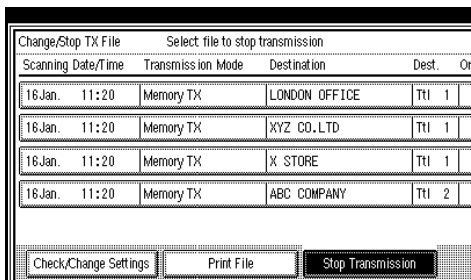

3 Select the file for which you want to change or cancel the transmission time.

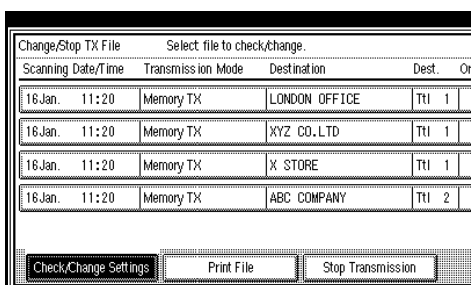

4 Press [Change TX time].

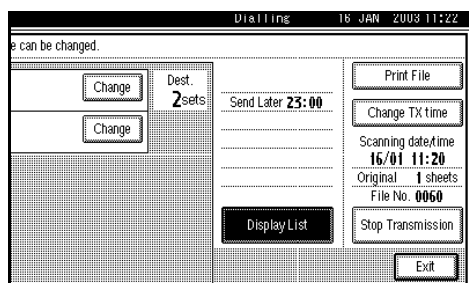

5 Press [Clear], and then reenter the transmission time using the number keys or select [Economy Time], and then press [OK].

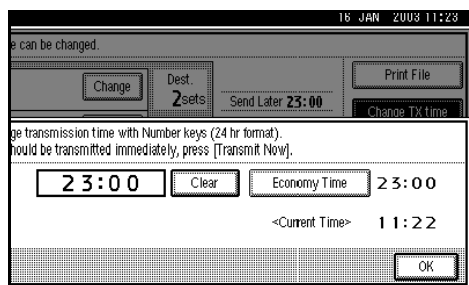

Note

- ❑ If you select **[Economy Time]**, the economy time already specified is entered. See p.130 “General Settings/Adjustment”.
- ❑ If you press **[Transmit Now]**, the file is transmitted immediately. However, if there is a file on standby, that file is sent first.

6 Press [Exit].

Note

- ❑ Repeat from step **3**, if you want to change another transmission time.

7 Press [Exit].

The standby display appears.

Printing a File

If you want to check the contents of a file that is stored in memory and not yet sent, use this procedure to print it out.

2

Note

- Confidential Transmission files are displayed, but cannot be printed.
- You can also print files that have not been successfully transmitted.

1 Press **[Change/Stop TX File]**.

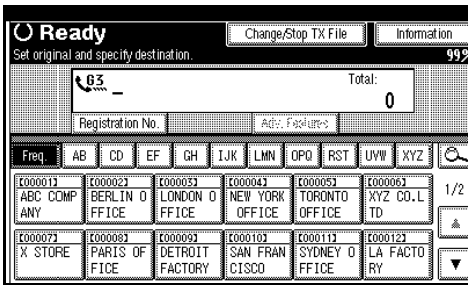

2 Press **[Print File]**.

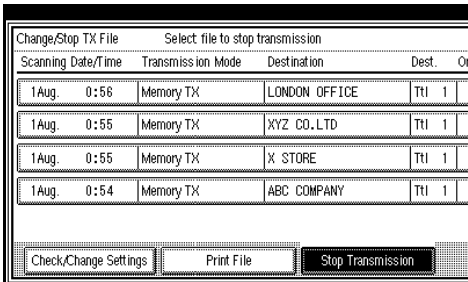

3 Select the file you want to print.

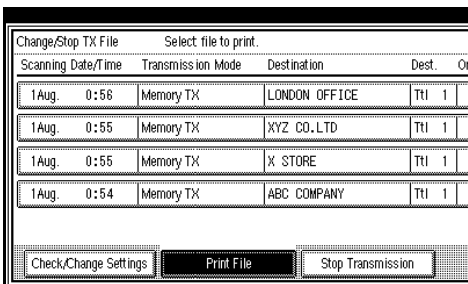

Note

- If multiple destinations were specified, only the number of unsent messages appears.
- If you want two-sided printing (optional), press **[Print 2 Sides]**.
- To cancel printing, press **[Cancel]**. The display returns to that of step **1**.

4 Press the **[Start]** key.

Note

- To cancel printing after pressing the **[Start]** key, press **[Stop Printing]**. The display returns to that of step **1**.

5 Press **[Exit]**.

The standby display appears.

Note

- Repeat from step **1**, if you want to print another file.

Resending a File

Machine memory stores messages that could not be successfully transmitted using Memory Transmission. Use this procedure to resend these messages.

Preparation

You should select “Store for 24 hours” for “Store a message that could not be transmitted” in User Parameters. See p.147 “Changing the User Parameters” (switch 24, bit 0).

Note

- Files that could not be transmitted will be kept for either 24 or 72 hours depending on how you program this function. See p.147 “Changing the User Parameters” (switch 24, bit 1).

1 Press [Change/Stop TX File].

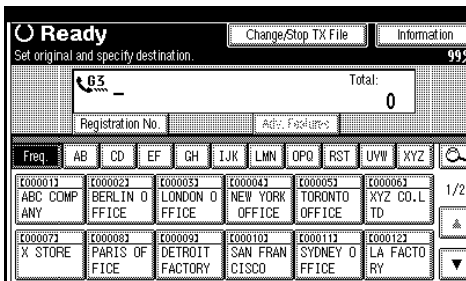

2 Press [Transmit Failed File].

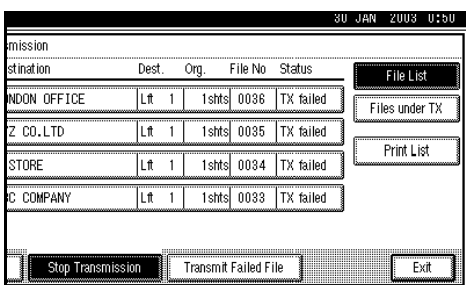

3 Select the file you want to resend.

“TX failed” is displayed for files that could not be sent.

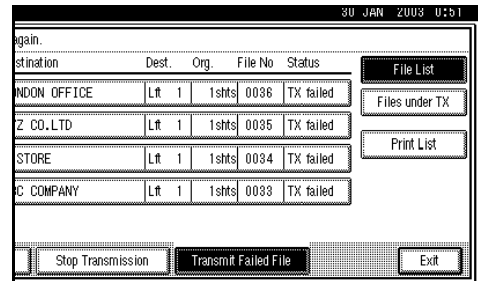

Note

- If multiple destinations were specified, only the destination number appears.
- If multiple destinations were specified, only the number of unsent messages appears.

4 Press [OK].

Note

- To add destinations, press [Add], and then specify the destinations.
- To cancel transmissions, press [Cancel]. The display returns to that of step **3**.
- Repeat from step **3** to resend another file.

5 Press [Exit].

The standby display appears.

Transmission starts.

Printing a List of Files in Memory (Print TX File List)

Print this list if you want to find out which files are stored in memory and what their file numbers are. Knowing the file number can be useful (for example when erasing files).

Note

- ❑ The contents of a file stored in memory can also be printed. See p.20 “Printing a File”.

1 Press [Change/Stop TX File].

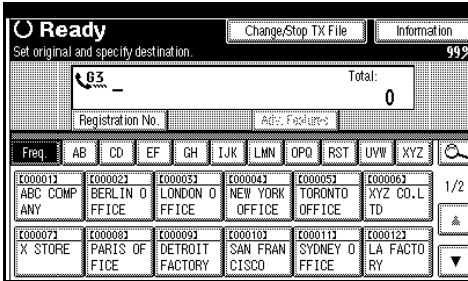

2 Press [Print List].

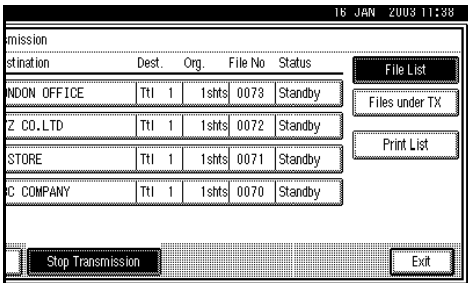

Note

- ❑ To cancel printing after pressing the [Start] key, press [Cancel]. The display returns to that of step 2.

3 Press the [Start] key.

Note

- ❑ To cancel printing after pressing the [Start] key, press [Stop Printing]. The display returns to that of step 2.

4 Press [Exit].

The standby display appears.

3. Communication Information

Printing the Journal

The Journal contains information about the last 50 communications (maximum) made by your machine. It is printed automatically after every 50 communications (receptions & transmissions).

You can also print a copy of the Journal at any time by following the procedure below.

If the machine is installed with the optional extra G3 interface unit, you can print the Journal of each line type.

Important

The contents of a Journal printed automatically are deleted after printing. Keep the journal if you require a record of transmissions and receptions. You can check a total of 200 communications (receptions & transmissions) on the display.

❖ All

Prints the results of communications in the order made.

❖ Print per File No.

Prints only the results of communications specified by file number.

❖ Print per User Code

Prints only the results of communications through User Code Management or User Transmission. See p.8 "User Code Entry Display", *Facsimile Reference <Basic Features>* and p.5 "User Transmission".

Note

- ❑ The setting on the machine can be changed so that user codes will be printed instead of user names. For more information, contact your service representative.
- ❑ The sender name column of the Journal is useful when you need to program a special sender. See p.152 "Special Senders to Treat Differently".
- ❑ You can set whether the Journal is automatically printed after every 50 communications in User Parameters. See p.147 "Changing the User Parameters" (switch 03, bit 7).
- ❑ You can set whether you print the Journal by line type. See p.147 "Changing the User Parameters" (switch 19, bit 1).
- ❑ You can program one of the Quick Operation keys with operations for this function. Using the key allows you to omit steps 1 and 2.

1 Press [Information].

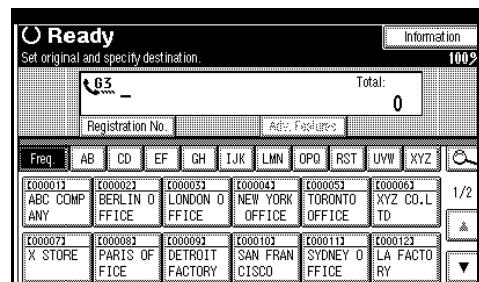

2 Select [Print Journal].

3 Select a printing mode.

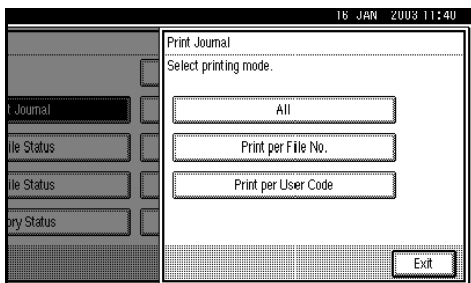

Selecting [All]

- 1 Press [All].

Selecting [Print per File No.]

- 1 Press [Print per File No.].
- 2 Enter a 4-digit file number.

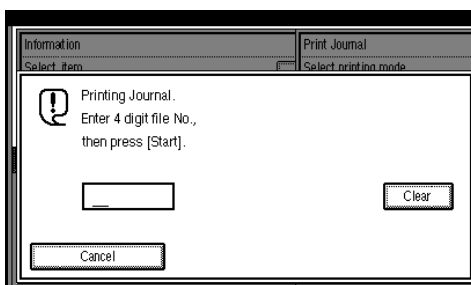

Note

- If you make a mistake, press [Clear] or the [Clear/Stop] key, and then try again.

Selecting [Print per User Code]

- 1 Press [Print per User Code].
- 2 Specify an 8-digit user code using the number keys, and then press [#].

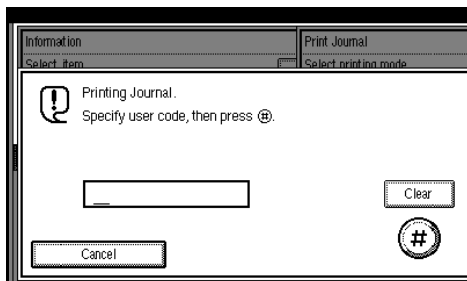

Note

- If you make a mistake, press [Clear] or the [Clear/Stop] key before pressing [#], and then try again.

- 3 Check the user name shown on the display.

- 4 Press the [Start] key.

Note

- To cancel a file printing, press [Stop Printing]. The display returns to that of step 2.

- 5 Press [Exit] twice.

The standby display appears.

Journal

* * * Journal (28. Sep 2003 18:38) * * *										
										P. 1
										1) ABC.COMPANY
										2) DESIGN
										(Manual print)
<TX>	Date	Time	Destination	Mode	TXtime	Page	Result	Pers. Name	File No.	
	28. Sep.	14:35	NEW YORK OFFICE	G3TESM	0'31"	P.1	OK		0528	7
		14:36	LONDON OFFICE	G3TESM	0'07"	P.2	---		0529	8
		14:40	PARIS OFFICE	G3TESM	0'01"	P.1	---		0530	2
		18:27	--LAN-Fax-->	*DM	0'02"	P.1	OK	DESIGN	0536	11
		18:28	NEW YORK OFFICE	G3TEDM	0'53"	P.1	OK	DESIGN	0536	10
										9
<RX>	Date	Time	Sender	Mode	RXtime	Page	Result	Pers. Name	File No.	
	28. Sep.	14:45	PARIS OFFICE	G3RES	0'04"	P.1	OK		0531	
		14:49	NEW YORK OFFICE	G3RESC	0'11"	P.2	OK		0532	
		15:00	LONDON OFFICE	G3RED	0'03"	P.1	OK		0533	
		15:30	LA FACTORY	G3RES	0'02"	P.1	OK		0534	
		15:32	BERLIN OFFICE	G3REF	0'03"	P.1	OK		0535	
T X Count		000021		R X Count		000020				
# : Batch	C : Confidential	\$: Transfer	P : Polling							
M : Memory	L : Send later	@ : Forwarding	E : ECM							
S : Standard	D : Detail	F : Fine	U : Super Fine							
> : Reduction	H : Stored/D.Server	* : LAN-Fax								

1. Printing date

Shows the date and time when the report is printed.

2. Programmed sender name

Shows the sender name programmed for printing.

3. Date

Shows the transmission or reception date.

4. Time

Shows the transmission or reception start time.

5. Other end

Shows the sender name (for display) programmed by the other end. Shows the programmed sender fax number if the sender name (for display) has not been programmed.

If neither sender name nor fax number has been programmed by the other end, an entered fax number or a name programmed in a Destination list is shown for transmissions. The space will be blank for receptions.

6. Communication mode

Shows a communication mode after transmission or reception. If the optional Extra G3 interface unit has been installed, "G3-1", "G3-2", or "G3-3" will be shown.

7. Communication time

Shows time taken for transmissions or receptions.

8. Number of pages

Shows the number of pages transmitted or received.

9. Communication result

Shows the result of transmissions or receptions.

OK: All pages were properly transmitted or received.

Error: A communication error occurred.

???: Power was disconnected during communication. Not all fax messages were transmitted.

10. User name

Shows the user name registered for user code use restriction or User Transmission.

11. File number

Shows file management numbers.

3

Checking the Transmission Result (TX File Status)

You can browse a part of the Transmission Result Report on the display.

Note

- ❑ Only the transmission result of the last 200 communications (receptions & transmissions) are shown.
- ❑ If a transmission is completed while you are using this function, the result will not appear. To view the latest result, exit TX File Status, and then try again.
- ❑ You can program one of the Quick Operation keys with operations for this function. Using the key allows you to omit steps **1** and **2**.

Note

- ❑ "Destination" shows the Own Fax Number or Fax Header information of a receiver. For a transmission from a computer, "-- LAN-Fax -->" is shown.

4 Press [Exit] twice.

The standby display appears.

1 Press [Information].

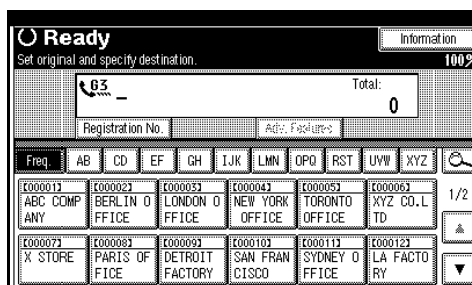

2 Select [TX File Status].

3 Check the transmission results.

TX File Status		Displaying transmission file status.	
Date/Time	Destination	Original	
16.Jan. 11:25	ABC COMPANY	1	
16.Jan. 11:22	NEW YORK OFFICE	1	
16.Jan. 10:35	LONDON OFFICE	1	
16.Jan. 10:20	TORONTO OFFICE	1	
16.Jan. 10:19	X STORE	1	
15.Jan. 14:49	PARIS OFFICE	1	

Transmission results are displayed, from the latest result down, in groups of six.

Checking the Reception Result (RX File Status)

You can browse a part of the Reception Result Report on the display.

Note

- Only the reception result of the last 200 communications (receptions & transmissions) are shown.
- If a message is received while you are using this function, the result will not appear. To view the latest result, exit RX File Status, and then try again.
- You can program one of the Quick Operation keys with operations for this function. Using the key allows you to omit steps 1 and 2.

Note

- Transmission Station shows the fax number of a sender or Fax Header information.

4 Press [Exit] twice.

The standby display appears.

1 Press [Information].

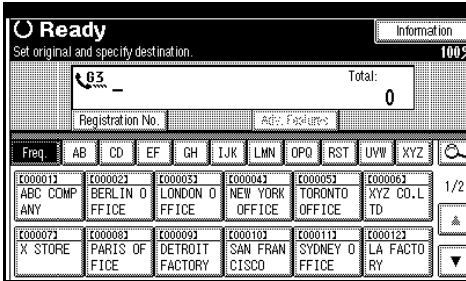

2 Select [RX File Status].

3 Check the reception results.

Date/Time	TX Station	Original
16.Jan. 10:40	ABC COMPANY	1
15.Jan. 13:56	NEW YORK OFFICE	2
15.Jan. 13:53	LONDON OFFICE	1
15.Jan. 13:52	X STORE	1

Reception results are displayed from the latest result in groups of six.

Displaying the Memory Status

Use this function to display a summary of current memory usage. Items shown are the percentage of free memory space, the number of received confidential messages, the number of files to be sent, the number of Memory Lock files and the number of received messages to be printed.

1 Press [Information].

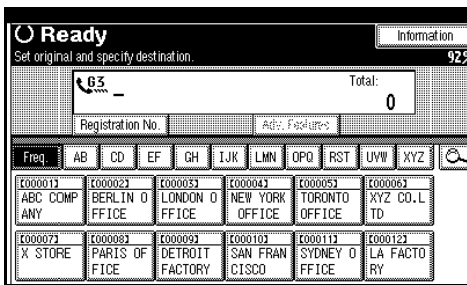

2 Press [Memory Status].

3 Check the memory status.

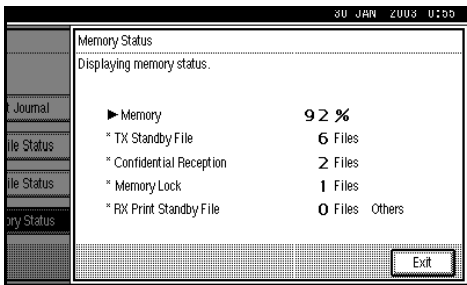

Note

☐ "Others" will be displayed:

- When storing attachment files. See p.138 "Storing, Changing, and Deleting an Auto Document".
- When storing Transfer Request files. See p.48 "Transfer Request".
- When storing originals in the Information Boxes. See p.38 "Information Boxes".

- When sending to the Personal Box. See p.36 "Personal Boxes".

☐ If you have made the machine save received messages on the hard disk, see "RX Print Standby File" on the display to check the number.

4 Press [Exit] twice.

The standby display appears.

Printing/Deleting Received and Stored Documents (Printing Stored RX File)

The optional printer/scanner unit or network board is required. When the network board is used, the optional SDRAM 128 MB is also required.

You can print documents that are received and stored on the hard disk. You can also delete unwanted documents.

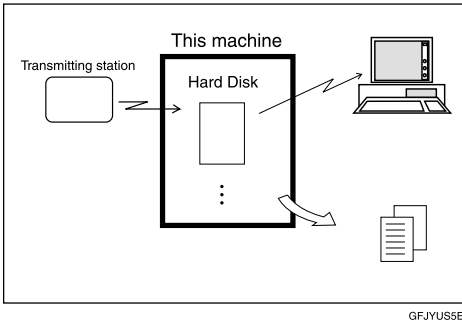

GFJYUS5E

Preparation

Make a setting for received and stored documents before using this function. See p.172 "Storing or Printing Received Documents".

Note

- You can view and/or print received and stored documents using a Web browser. See p.109 "Viewing Fax Information Using a Web Browser".

Printing Received and Stored Documents

Use the following procedure to print documents saved on the hard disk.

Note

- This function allows you to print only received and stored documents.
- Received documents cannot be used for the Document Server function.
- You can specify and print multiple documents. You can specify a maximum of 30 documents at one time.

1 Press [Information].

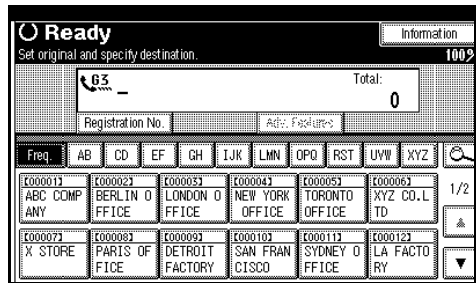

2 Press [Print Stored RX File].

3 Select the document to be printed, and then press [Print].

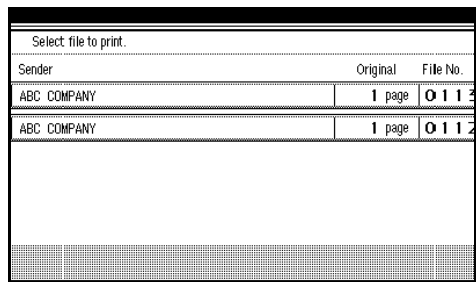

- 4 Select the printing mode, and then press the **[Start]** key.

Note

- To cancel printing, press **[Cancel]**. The display returns to that of step 3.
- To delete the document after printing, press **[Delete File after Printing]**.
- To perform 2-sided printing (optional duplex unit required), press **[Print on 2 sides]** before pressing the **[Start]** key.

- 5 Press **[Exit]** twice.

The standby display appears.

Deleting Received and Stored Documents

Use the following procedure to delete documents stored on the hard disk.

Note

- You cannot delete a document while another person is viewing or printing it using a Web browser.

- 1 Press **[Information]**.

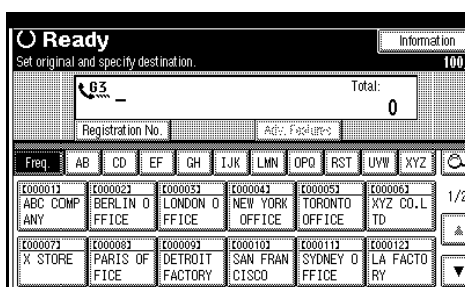

- 2 Press **[Print Stored RX File]**.

- 3 Select the document to be deleted, and then press **[Delete]**.

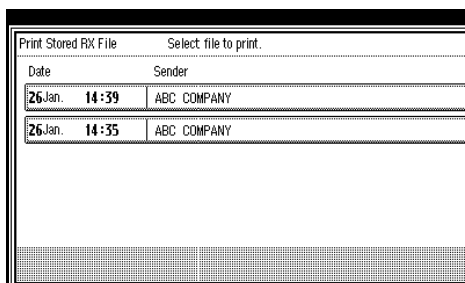

- 4 Press **[Yes]**.

Note

- To cancel a deletion, press **[No]**. The display returns to that of step 3.

- 5 Press **[Exit]** twice.

The standby display appears.

Printing a Confidential Message

This function is designed to prevent unauthorized users from reading your messages. If someone sends you a message using Confidential Transmission, it is stored in memory but not automatically printed. To print the message you have to enter the Confidential ID Code. When your machine has received a confidential message, the **Confidential File** (📧) indicator lights.

3

Preparation

Before using this function, program your Confidential ID. See p.170 “Programming a Confidential ID”.

Important

- ❑ If the main power switch is off more than one hour, all confidential messages are deleted. When this happens, use the Power Failure Report to identify which messages have been deleted. See p.175 “Power Failure Report”.

Limitation

- ❑ You must program the Confidential ID for Confidential Reception to work.

Note

- ❑ You can program one of the Quick Operation keys with operations for this function. Using the key allows you to omit steps 2 and 3.

1 Confirm that the Confidential File indicator is lit.

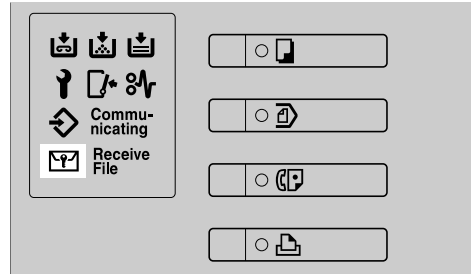

ZHPS061E

2 Press [Information].

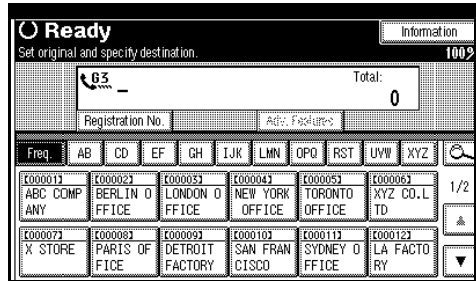

3 Select [Print Confidential RX File].

Note

- ❑ If no confidential messages have been received, the message “No reception file.” is shown. Press [Exit].

4 Enter a 4-digit Confidential ID using the number keys, and then press the [Start] key.

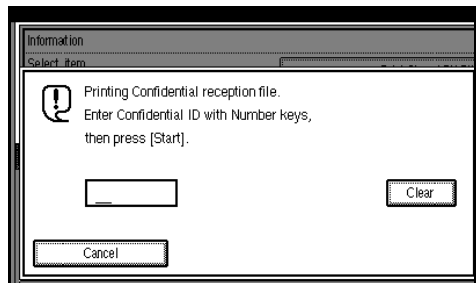

 **Note**

- You must enter the Confidential ID programmed in this machine, if the received file has no Confidential ID.
- You must enter the Confidential ID programmed by the sender. Confirm the sender's Confidential ID in advance.
- If the Confidential IDs or Personal Confidential IDs do not match, the message "No reception file under specified Confidential ID." appears. Press **[Exit]** to cancel the operation, and then check the Confidential ID or Personal Confidential ID with the other party, and then try again.

5 Press **[Exit]**.

The standby display appears.

 **If you cannot print confidential files even if the Confidential File (CF) indicator is lit.**

The Confidential File indicator also lights if the machine received a message with a SUB code. Check the Personal Boxes.

 **Note**

- Print from the Personal Box, when a file has been sent from another party with a SUB code attached. See p.36 "Personal Boxes".

Confidential File Report

When this function is turned on, this report is printed whenever your machine receives a confidential message.

 **Note**

- You can turn this function on or off with the User Parameters. See p.147 "Changing the User Parameters" (switch 04, bit 0).

Printing a File Received with Memory Lock

This is a security function designed to prevent unauthorized users from reading your messages. If Memory Lock is switched on, all received messages are stored in memory and are not automatically printed. To print the messages, you have to enter the Memory Lock ID Code. When your machine has received a message with Memory Lock, the **Confidential File** (📧) indicator blinks.

3

Preparation

Before using this function, program your Memory Lock ID. See p.171 “Programming a Memory Lock ID”.

Before using this function, set Confidential Transmissions to On.

Important

- ❑ If the main power switch is turned off for more than an hour, all messages protected by Memory Lock will be deleted. In that case, the Power Failure Report will be printed so you can confirm which messages have been deleted. See p.175 “Power Failure Report”.

Note

- ❑ If free memory space is low, messages may not be received.
- ❑ You can also apply a Memory Lock to messages that come only from certain senders. See p.152 “Special Senders to Treat Differently”.
- ❑ Messages received by Polling Reception are automatically printed even if this function is switched on.
- ❑ You can program one of the Quick Operation keys with operations for this function. Using the key allows you to omit steps 2 and 3.

- 1 Confirm that the Confidential File indicator is blinking.

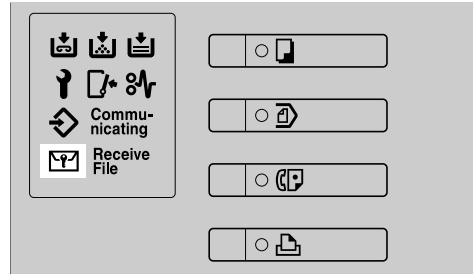

ZHPS061E

- 2 Press [Information].

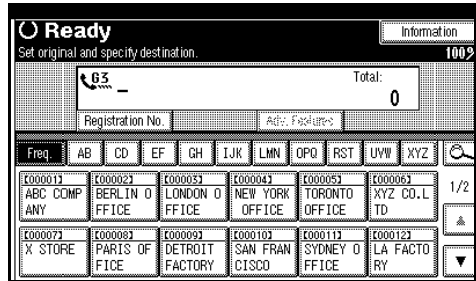

- 3 Select [Print Memory Lock].

Note

- ❑ If no messages were received while Memory Lock was switched on, the message “No reception file.” is shown. Press [Exit].

- 4 Enter a 4-digit Memory Lock ID with the number keys, and then press the [Start] key.

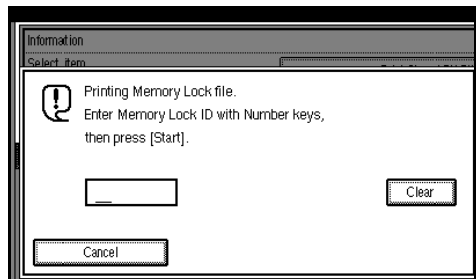

 **Note**

- ❑ If the Memory Lock ID does not match, the message “Specified code does not correspond to programmed Memory Lock ID.” appears. Press **[Exit]** and retry after checking the Memory Lock ID.

5 Press **[Exit]**.

The standby display appears.

Personal Boxes

Preparation

Before using this function, set the Personal Box in advance. See p.161 "Programming/editing Personal Boxes".

Personal Boxes

This function lets you set up the machine so that incoming messages addressed to certain users are stored in memory instead of being printed out immediately. Each user must be assigned a SUB code (Personal Code) that has been designated as a Personal Box beforehand. When the other party sends their message, they specify the SUB code of the user to which they are sending. When the message is received, it is stored in the Personal Box with the matching SUB code. In order to print a message received into a Personal Box, you must enter the SUB code assigned to that Personal Box. This enables several individuals or departments to share a single fax machine yet be able to differentiate between messages. Furthermore, if you specify a receiver for the Personal Box, instead of being stored in memory, incoming messages with this SUB code appended are forwarded directly to the destination you specify.

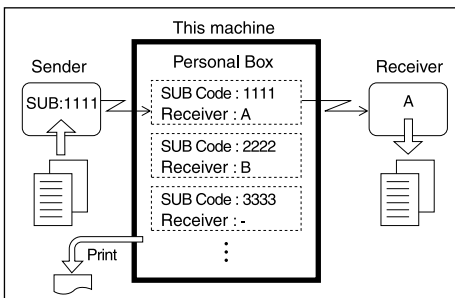

GFSINB0N

- To be able to receive messages into a Personal Box you must inform the sender of the SUB code registered for that Personal Box and ask them to send the message using SUB Code Transmission with that SUB code. See p.45 "SUB Code".
- When messages have been received into Personal Boxes, the Confidential Reception/Memory Lock indicator lights and the Confidential File Report is printed. See p.33 "Confidential File Report".
- If a Personal Box is assigned a receiver, incoming messages are transferred to that receiver with a Forwarding Mark stamped on them. See p.143 "Forwarding".
- If a receiver is not assigned, print these messages. See p.36 "Printing Personal Box Messages".

Printing Personal Box Messages

Follow these steps to print a message that has been received into a Personal Box.

Note

- If you print a Personal Box message, it is deleted.

1 Confirm that the Confidential File indicator is lit.

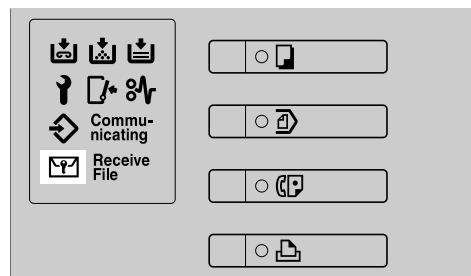

ZHPS061E

2 Press [Information].

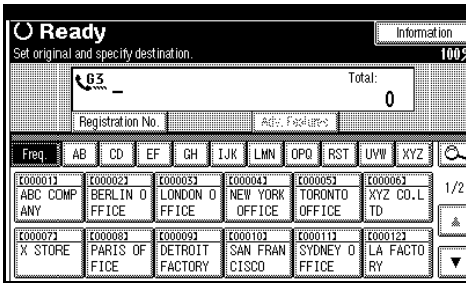

3 Select [Print Personal Box File].

4 Select the box with the message you want to print.

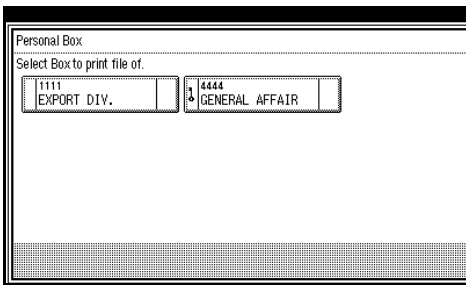

When a password is required

The display appears, when the selected Personal Box password is set in advance.

Note

- The password is registered in "Key Operator Tools". See p.161 "Programming/editing Personal Boxes".

1 Enter the password, and then press [OK].

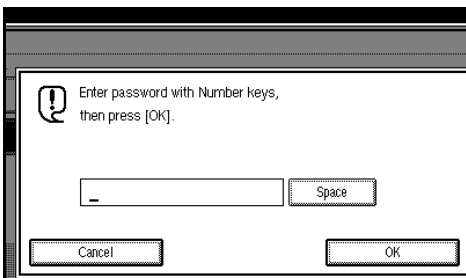

Note

- If you make a mistake, press [Clear] or the [Clear/Stop] key before pressing [OK], and then try again.
- To cancel entering a password, press [Cancel]. The display returns to that of step 4.

5 Press the [Start] key.

Note

- To stop printing, press [Stop Printing]. The display returns to that of step 4.

6 Press [Exit].

Note

- To print a message in another Personal Box, refer to step 4, and then try again.

7 Press [Exit].

The standby display appears.

Information Boxes

Preparation

Before using this function, set the Information Box in advance. See p.163 “Programming/editing Information Boxes”.

Information Boxes

Use the Information Box function to set up the machine as a Fax Information service or Document Server. By scanning documents into Information Boxes, other parties can receive these messages whenever they request them.

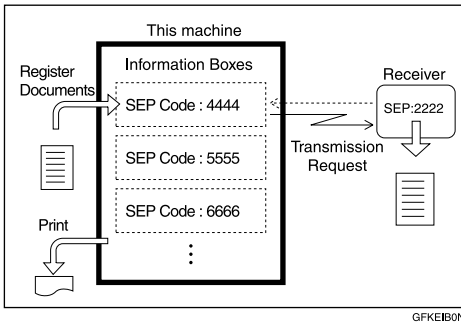

- You can program documents for this function with “Storing Messages in Information Boxes”. See p.38 “Storing Messages in Information Boxes” .
- For other parties to be able to retrieve a message programmed in an Information Box, you need to inform them of the SEP code assigned to that Information Box.
- When an SEP Code Polling Reception request is made by another party, the SEP code they specify is matched against the SEP codes programmed in that Information Boxes. If a code matches, the message stored in the Information Box is sent to the other party automatically.

- You can check the contents of Information Boxes with “Printing Information Box Messages”. See p.40 “Printing Information Box Messages”.
- You can set a password for Information Boxes in advance. A password can be set in “Key Operator Setting”. See p.163 “Programming/editing Information Boxes”.

Storing Messages in Information Boxes

Follow these steps to store a message in an Information Box.

Note

- One Information Box stores one file.
- The stored file is not deleted automatically. If you want to delete a stored file, see p.41 “Deleting Information Box Messages”.

1 Press [Information].

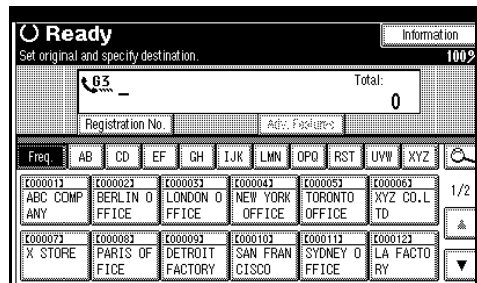

2 Select [Store/Delete/Print Information Box File.].

- 3** Select the box in which you want to store the file.

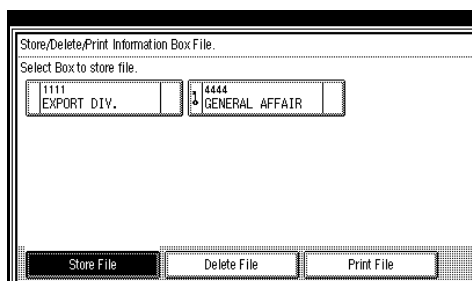

Note

- When there are pre-registered files, a file mark is displayed at the end of the Box Name.
- A message is displayed, when selecting a box with a file stored in it. Press **[Yes]**, when changing the file name. The file stored originally will be overwritten.

When a password is required

- 1** Enter the password, and then press **[OK]**.

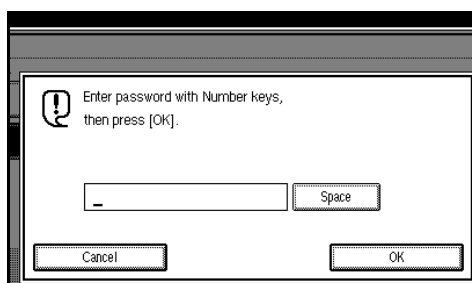

Note

- If you make a mistake, press **[Clear]** or the **[Clear/Stop]** key before pressing **[OK]**, and then try again.
- To cancel entering a password, press **[Cancel]**. The display returns to that of step **3**.

- 4** Place the original, and then select the scan settings you require.



Note

- You can also select the following settings:
 - Book Fax
 - Two-Sided Original (The optional Auto Document Feeder (ADF) is required.)
 - Stamp (The optional Auto Document Feeder (ADF) is required.)

Reference

p.11 "Placing Originals", *Facsimile Reference* <Basic Features>

p.27 "Scan Settings", *Facsimile Reference* <Basic Features>

- 5** Press the **[Start]** key.

The machine starts to scan the original.

To stop scanning, press **[Stop Scanning]**. The display returns to that of step **3**.

- 6** Press **[Exit]**.

Note

- To store a message in another Information Box, return to step **3**.

- 7** Press **[Exit]**.

The standby display appears.

Printing Information Box Messages

Follow these steps to print a message stored in an Information Box.

1 Press [Information].

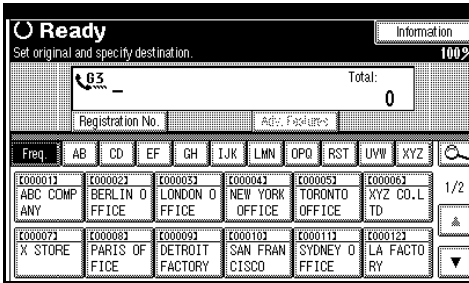

2 Select [Store/Delete/Print Information Box File.].

3 Press [Print File].

4 Press [Print File], and select the box that contains the stored file you want to print.

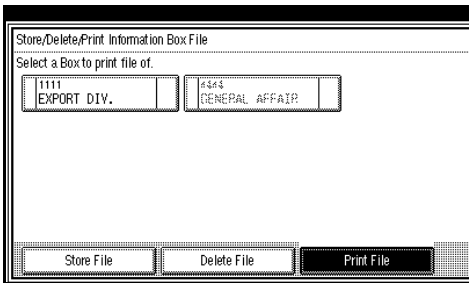

Note

- You cannot select a box that has no stored file.

When a password is required

1 Enter the password, and then press [OK].

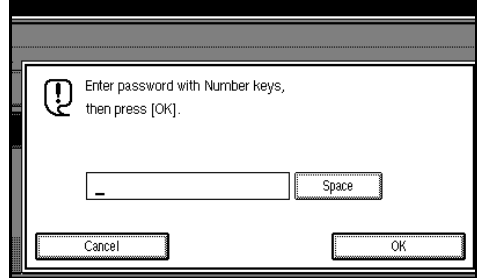

Note

- If you make a mistake, press [Clear] or the [Clear/Stop] key before pressing [OK], and then try again.
- To cancel entering a password, press [Cancel]. The display returns to that of step 4.

5 Press the [Start] key.

Note

- If you want two-sided printing (optional), press [Print 2 Sides] before pressing the [Start] key.
- To stop printing before pressing the [Start] key, press [Cancel]. The display returns to that of step 4.
- To stop printing after pressing the [Start] key, press [Stop Printing]. The display returns to that of step 4.

6 Press [Exit].

Note

- Repeat from step 4 to print another stored file in the box.

7 Press [Exit].

The standby display appears.

Deleting Information Box Messages

Follow these steps to delete a file stored in an Information Box.

1 Press **[Information]**.

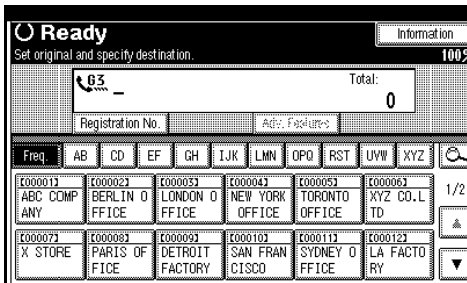

2 Select **[Store/Delete/Print Information Box File.]**.

3 Press **[Delete File]**.

4 Select the box that contains the stored file you want to delete.

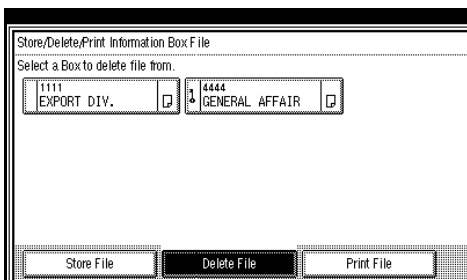

When a password is required

1 Enter the password, and then press **[OK]**.

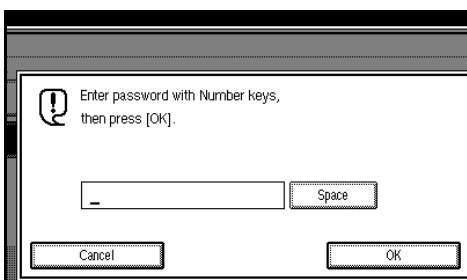

Note

- If you make a mistake, press **[Clear]** or the **[Clear/Stop]** key before pressing **[OK]**, and then try again.
- To cancel entering a password, press **[Cancel]**. The display returns to that of step **4**.

5 Press **[Delete]**.

Note

- To stop deleting, press **[Do not Delete]**. The display returns to that of step **4**.

6 Press **[Exit]**.

Note

- Repeat from step **4** to delete another stored file in another box.

7 Press **[Exit]**.

The standby display appears.

4. Other Transmission Features

Handy Dialing Functions

Chain Dial

This allows you to compose a telephone number from various parts, some of which may be stored in Quick Dials and some of which may be entered using the number keys.

 **Note**

- Maximum length of a telephone or fax number: 128 digits
- For Memory Transmission and Immediate Transmission, insert a pause between parts of a number. For On Hook Dial and Manual Dial, no pause is needed.

(Example) 01133-1-555333

Assume that 01133 is stored in a Quick Dial key.

- 1** Place the original, and then select the scan settings you require.
- 2** Press the Quick Dial key that is programmed "01133".
- 3** Press the **[Pause/Redial]** key.
- 4** Enter **[1]**, **[5]**, **[5]**, **[5]**, **[3]**, **[3]**, **[3]** using the number keys.
- 5** Press the **[Start]** key.

Redial

The machine stores the last 10 destinations dialed. If you want to send a message to a destination which you sent faxes to recently, the Redial function saves you time by finding and entering the number again.

 **Limitation**

- The following kinds of destinations are not stored:
 - Quick Dials
 - Group Dials
 - Destinations dialed as End Receivers for Transfer Request
 - Forwarding terminal of the Substitute Reception
 - Destinations dialed using the external telephone
 - Destinations dialed by Redial (regarded as already stored in memory)
 - Second and later destinations broadcasted to
- Do not dial any numbers before you press the **[Pause/Redial]** key. If you press the **[Pause/Redial]** key after entering numbers using the number keys, a pause will be entered instead.

1 Press the **[Pause/Redial]** key.

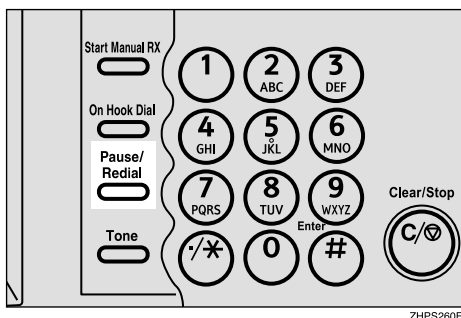

2 Select the destination you want to redial to.

4

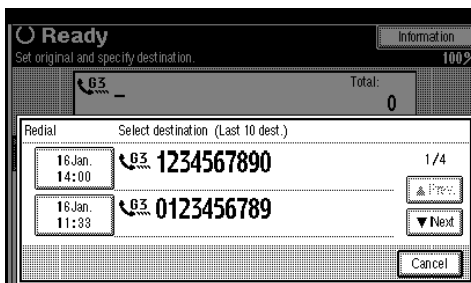

Note

- Now that the date and time the original was read appears as a key, select by pressing it.

Advanced Features

SUB Code

Normally you can only use Confidential Transmission to send messages to fax machines of the same manufacturer that have the Confidential Reception function. See p.7 “Confidential Transmission”. However, if the other machine supports a similar function called “SUB Code”, you can send fax messages to the other party using this method instead.

Note

- ❑ The ID can be up to 20 digits long.
- ❑ You can enter numbers, *, #, and spaces to program an ID.
- ❑ Make sure the number of digits in the ID matches the specification of the machine to which you are sending.
- ❑ You can store IDs in Destination lists and Programs. See “Registering a Fax Destination”, *General Settings Guide*. See p.113 “Registering and Changing Keystroke Programs”.
- ❑ Messages you send using this function are marked “SUB” on all reports.

1 Place the original, and then select the scan settings you require.

2 Dial the fax number using the number keys.

3 Press [Adv. Features].

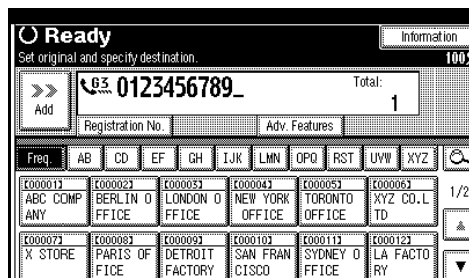

4 Select [SUB Code].

5 Press [TX SUB Code].

6 Enter a SUB code, and then press [OK].

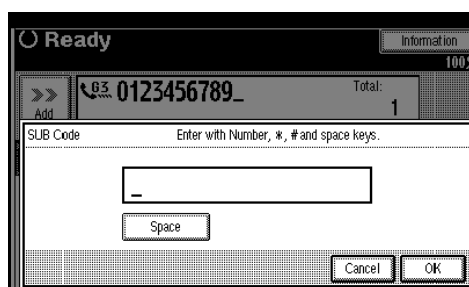

“SUB Code” appears one line above [Adv. Features] on the display.

Note

- ❑ If you make a mistake, press [Cancel] or the [Clear/Stop] key before pressing [OK], and then try again.

To cancel entering a SUB code, press [Cancel]. The display returns to that of step 3.

7 To enter a password, press [Password (SID)].

8 Enter the password with the number keys, and then press [OK].

4

9 Press [Exit].

10 Press the [Start] key.

Note

- If you use Immediate Transmission and the fax machine at the destination does not support the SUB Code function, a message will appear on the display to inform you of this. When this happens, press [OK] to cancel the transmission.

4

SID Code

There are times when you may want to use an "SID" (Sender ID) when sending confidential faxes with the SUB Code function.

Note

- The ID can be up to 20 digits long.
- You can enter numbers, *, #, and spaces to program an ID.
- You can store IDs in Destination lists and Programs. See p.113 "Registering and Changing Keystroke Programs". See "Registering a Fax Destination", *General Settings Guide*.
- Messages you send using this function are marked "SID" on all reports.

SEP Code

Normally you can only use Polling Reception to receive faxes from machines that have the Polling Reception function and the same manufacturer. However, if a machine of another manufacturer supports Polling Reception, you can receive fax messages from the other party using this method instead.

You can receive messages that have the same SEP code as the SEP code you entered.

Note

- The ID can be up to 20 digits long.
- Make sure the number of digits in the ID matches the one set on the machine to which you are sending.
- You can enter numbers, *, #, and spaces to program an ID.
- You can store IDs in Destination lists and Programs. See "Registering a Fax Destination", *General Settings Guide*. See p.113 "Registering and Changing Keystroke Programs".
- Messages you receive using this function are marked "SEP" on all reports.

1 Dial the fax number using the number keys.

2 Press [Adv. Features].

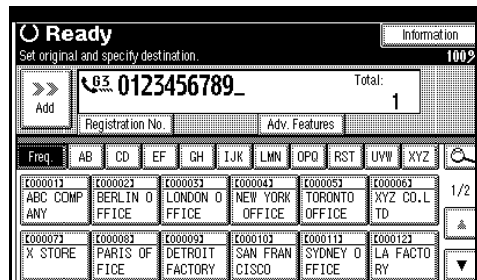

- 3 Select [SEP Code].
- 4 Press [RX SEP Code].
- 5 Enter a SEP code, and then press [OK].

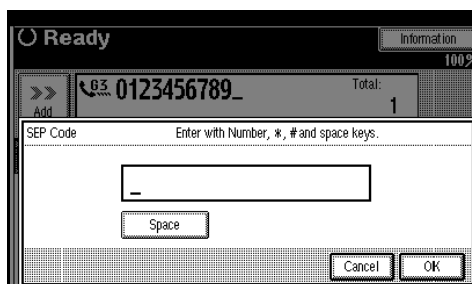

“SEP Code” appears one line above [Adv. Features] on the display.

Note

- If you make a mistake, press [Cancel] or the [Clear/Stop] key before pressing [OK], and then try again.

To cancel entering a SEP code, press [Cancel]. The display returns to that of step 4.

- 6 To enter a password, press [Password (PWD)].
- 7 Enter the password using the number keys, and then press [OK].
- 8 Press [Exit].
- 9 Press [Transmission Mode].

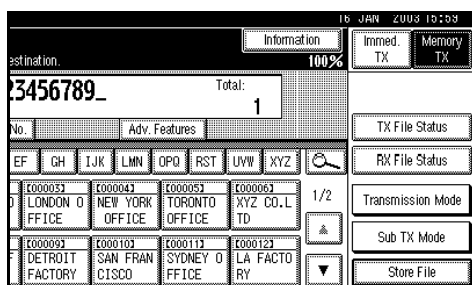

- 10 Select [Polling RX].

- 11 Press [Default ID/Free Polling RX], and then press [OK].

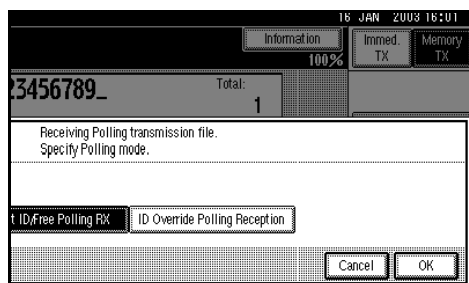

[Polling RX] is highlighted, and “Default ID/Free Poll.” is shown.

Note

- To cancel Polling RX, press [Cancel]. The display returns to that of step 10.

- 12 Press [OK].

The standby display appears.

- 13 Press the [Start] key.

PWD Code

There are times you may want to use a password when receiving faxes by polling using the SEP Code function.

Note

- The password can be up to 20 digits long.
- You can enter numbers, *, #, and spaces as a password.
- You can store IDs in Destination lists and Programs. See "Registering a Fax Destination", *General Settings Guide*. See p.113 "Registering and Changing Keystroke Programs".
- Messages you send using this function are marked “PWD” on all reports.

Transfer Request

Transfer Request allows fax machines that have this function to automatically distribute incoming messages to multiple fax destinations. This function helps you save costs when you send the same message to more than one place in a distant area, and saves time since many messages can be sent in a single operation.

The diagram below may make the concept clearer.

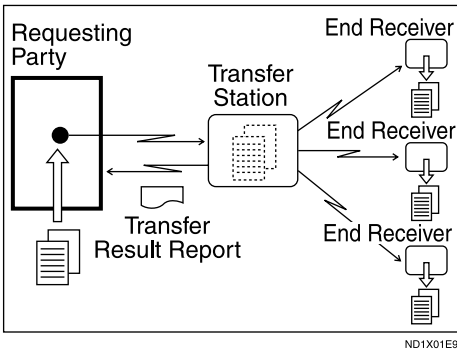

The following terminologies are used in this section:

❖ **Requesting Party**

The machine where the message originates.

❖ **Transfer Station**

The machine that forwards the incoming message to another destination.

❖ **End Receiver**

The final destination of the message or the machine to which the Transfer Station sends to.

📁 **Preparation**

Before you can use this function, you must program the Polling ID and your own fax number. See p.170 "Programming a Polling ID", p.169 "Transfer Report".

💡 **Limitation**

- ❑ The Transfer Stations you specify must be machines of the same manufacturer and have the Transfer Station function.
- ❑ You cannot use Transfer Request without programming the fax number of the Requesting Party in a Quick Dial or Speed Dial.

📝 **Note**

- ❑ Polling ID's of the Requesting Party (this machine) and Transfer Stations must be identical.
- ❑ You can specify up to 500 Transfer Stations in a Transfer Request.
- ❑ You can have up to 30 End Receivers per Transfer Station. If you specify a Transfer Station Group, the Group counts as a single receiver.
- ❑ You can program one of the Quick Operation keys with operations for this function. Using the key allows you to omit steps 3 and 4.

1 Place the original, and then select any scan settings you require.

🔍 **Reference**

p.11 "Placing Originals", *Facsimile Reference* <Basic Features>

p.27 "Scan Settings", *Facsimile Reference* <Basic Features>

2 Dial a Transfer Station.

📝 **Note**

- ❑ Enter the fax numbers of the Transfer Stations using either the Quick Dial or number keys.
- ❑ If you make a mistake, press the **[Clear/Stop]** key, and then try again.

🔍 **Reference**

p.32 "Dialing", *Facsimile Reference* <Basic Features>

3 Press [Adv. Features].

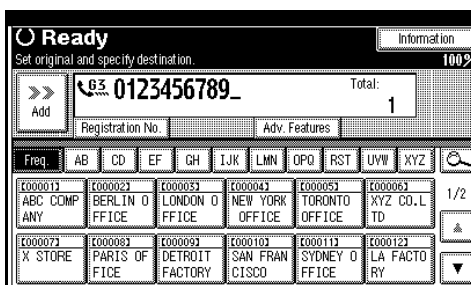

4 Select [Transfer Req.].

5 Press [Receiving Station].

6 Dial an End Receiver.

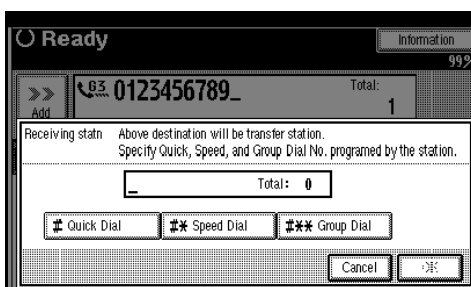

Note

- You cannot enter End Receiver numbers directly. The numbers must be stored in Destination lists, Speed Dial, or Groups in the Transfer Station(s). To specify an End Receiver, use the procedure described below.
- To cancel the Transfer Request, press [Cancel]. The display returns to that of step 5.

Destination List

1 Press [# Quick Dial].

2 Enter the number of the Destination list where the End Receiver is stored.

For example, to select the number stored in Quick Dial 01 of the Transfer Station, enter: [0][1].

Speed Dial

1 Press [#* Speed Dial].

2 Enter the number of the Speed Dial code.

For example, to select the number stored in Speed Dial 12 of the Transfer Station, enter: [1][2].

Group Dial

1 Press [#** Group Dial].

2 Enter the number of the Group number.

For example, to select the number stored in Group Dial 04 of the Transfer Station, enter: [0][4].

7 To specify another End Receiver, press [Add].

Note

- Press [▲ Prev.] or [▼ Next] to see the End Receivers already entered. You can select an End Receiver from this list and remove it by pressing [Clear] or the [Clear/Stop] key.

8 When you have specified all the End Receivers, press [OK].

9 Press [Exit].

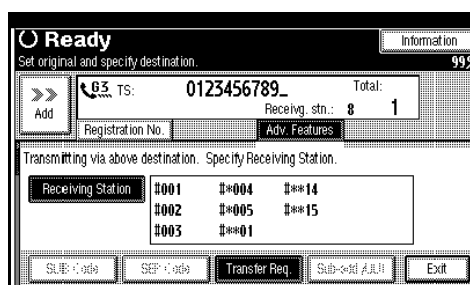

The Transfer Stations and End Receivers are displayed.

10 Press the [Start] key.

With Transfer Requests set in the System Settings

You can program a Quick Dial key with Transfer Station and/or End Receiver using the Transfer Request function in the System Settings. See the *General Settings Guide*.

1 Place the original down, and then select the desired settings.

 **Reference**

p.11 "Placing Originals", *Facsimile Reference* <Basic Features>

p.27 "Scan Settings", *Facsimile Reference* <Basic Features>

2 Press the key programmed with Transfer Request.

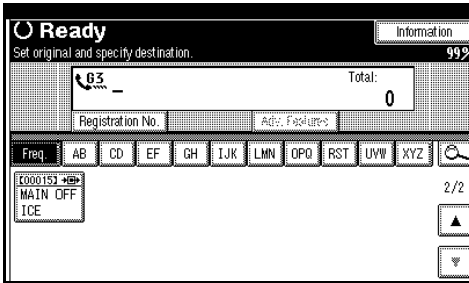

3 Press the **[Start]** key.

Setting Multistep Transfer

Register a Transfer Station in a Destination list. When receiving a transfer request that specifies the same End Receiver as programmed in the Destination list, this machine sends a transfer request to the programmed Transfer Station. This function allows fax messages to be transferred via multiple stations and makes fax message transfer more efficient.

You can program up to 30 End Receivers per Transfer Station. For more information, contact your service representative.

On Hook Dial

This is just like using the external telephone, except you do not have to pick up the external telephone before dialing. Just press the **[On Hook Dial]** key and dial the number. If you hear a voice, you can pick up the external telephone and speak with the other party.

Limitation

- This function is unavailable for the optional extra G3 interface unit.

Note

- This function is unavailable in some countries.

- 1** Place the original, and then select the scan settings you require.

Reference

p.11 "Placing Originals", *Facsimile Reference* <Basic Features>

p.27 "Scan Settings", *Facsimile Reference* <Basic Features>

- 2** Press the **[On Hook Dial]** key.

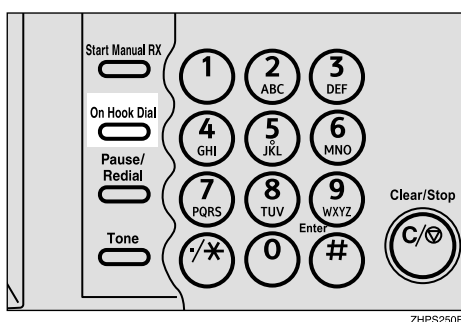

You will hear a low tone from the internal speaker.

Note

- If you want to cancel this operation, press the **[On Hook Dial]** key again.

- 3** Dial.

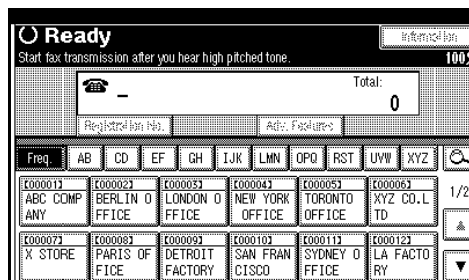

The machine immediately dials the destination.

Note

- You can adjust the volume of the On-hook sound by pressing **[Higher]** or **[Lower]** in the upper right-hand corner of the display. The volume can also be preprogrammed in "General Settings and Adjustments". See p.49 "Adjusting the Volume", *Facsimile Reference* <Basic Features>.
- If you make a mistake, press the **[On Hook Dial]** or **[Clear Modes]** key, and then return to step 2.

- 4** When the line is connected and you hear a high-pitched tone, press the **[Start]** key.

Note

- If you hear a voice, pick up the external telephone before you press the **[Start]** key and notify the receiver that you want to send a fax message (ask them to switch to facsimile mode).
- After transmission, the machine returns to standby mode.
- If you want to cancel a transmission, press the **[Clear/Stop]** key, and then remove the originals.

Manual Dial

The external telephone is required.

Pick up the handset of the external telephone and dial. When the line is connected and you hear a high-pitched tone, press the **[Start]** key to send your fax message. If, on the other hand, you hear a voice at the other end, continue conversation as normal.

Limitation

- This function is unavailable for the optional extra G3 interface unit.
- The result of a transmission with Manual Dial is not mentioned in the Transmission Result Report (Immediate Transmission).

1 Place the original, and then select the scan settings you require.

Reference

p.11 "Placing Originals", *Facsimile Reference* <Basic Features>

p.27 "Scan Settings", *Facsimile Reference* <Basic Features>

2 Pick up the external telephone.

You will hear a tone.

3 Dial.

Note

- If you make a mistake, replace the external telephone, and then try again from step **2**.

4 When the line is connected and you hear a high-pitched tone, press the **[Start]** key to send your fax message.

Note

- If you hear a voice, tell the receiver that you want to send them a fax message (ask them to switch to facsimile mode).

5 Replace the handset of the external telephone.

After transmission, the standby display appears.

Note

- If you want to cancel a transmission, press the **[Clear/Stop]** key, and then remove the originals.

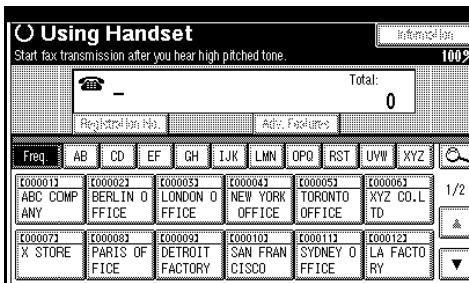

The machine immediately dials the destination.

Changing the Line Port

The optional extra G3 interface unit is required.

When the extra G3 interface unit is installed, you can connect to a maximum of three ports.

Note

- When you install the extra G3 interface unit, you can specify the line port home position from “Gen. Settings/Adjust”. See p.130 “General Settings/Adjustment”.
- When sending a fax, you can select the line port if dialing with the number keys or Chain Dial.

◆ G3

G3 is selected after power up or when the machine is reset. If you install the extra G3 interface unit, you can select “G3-1”, “G3-2”, “G3-3”, or “G3-Auto” depending on the number of the installed unit.

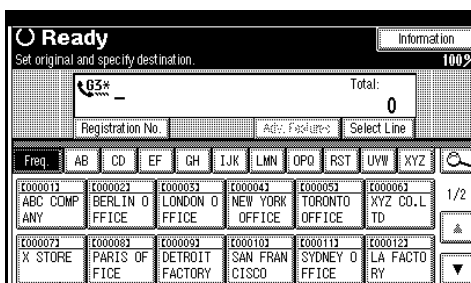

◆ Multi-port

When the extra G3 interface unit is installed, communications can take place simultaneously through two lines at once.

The following list shows protocol combinations available for each line type.

Option	Available line types	Available protocol combinations
Without option	PSTN	G3
Extra G3 interface unit	PSTN+PS TN	G3+G3
Extra G3 interface unit + Extra G3 interface unit	PSTN+PS TN+PSTN	G3+G3+G3

Note

- A maximum of three communications can take place simultaneously.
- You cannot perform three Immediate Transmissions simultaneously.
- If three communications are in progress, the display shows the first communication that was initiated.

1 Press [Select Line].

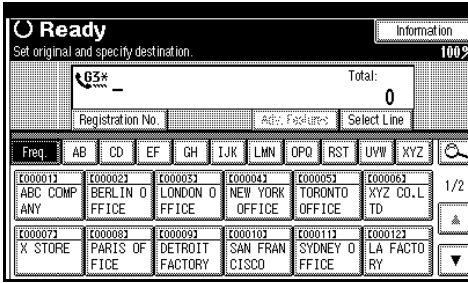

2 Select the line you want to use.

When one optional extra G3 unit is installed.

4

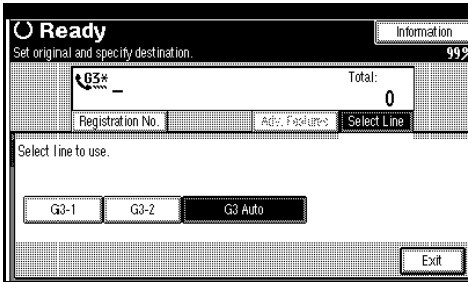

When two optional extra G3 units are installed.

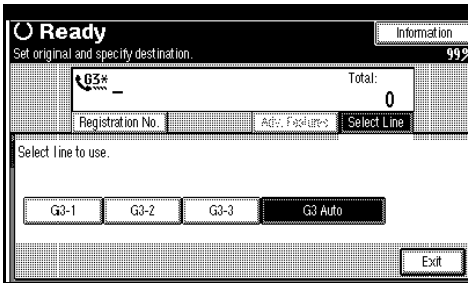

Note

- If you select "G3 Auto", the machine will use any available line. This increases efficiency.

3 Press [Exit].

The standby display appears.

Sub Transmission Mode

Book Fax

Use to send book originals from the exposure glass. Pages are scanned in the order shown below.

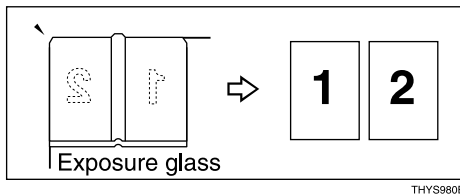

Limitation

- Place the original on the exposure glass. You cannot use the optional Auto Document Feeder (ADF).
- Depending on paper sizes available in the destination machine, the message may be reduced when printed at the other end.

Note

- You can have bound originals scanned as left or right page first. You can set which page (left or right) the machine scans first as default with the User Parameters. See p.147 "Changing the User Parameters" (switch 06, bit 6).

- 1** Place the original on the exposure glass, and then select the scan settings you require.

Reference

p.11 "Placing Originals", *Facsimile Reference* <Basic Features>

p.27 "Scan Settings", *Facsimile Reference* <Basic Features>

- 2** Press [Sub TX Mode].

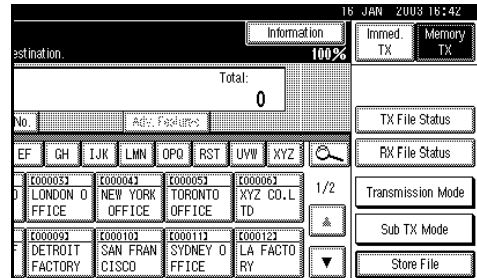

- 3** Select [Book Fax].

- 4** Select the size of the original.

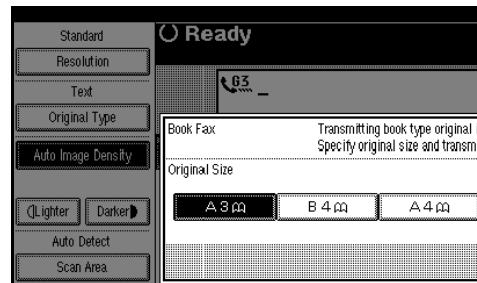

Note

- To cancel this mode, press [Cancel]. The display returns to that of step 3.
- If you select A3, the original will be sent using Image Rotation Transmission. See p.73 "Transmission with Image Rotation".

- 5** Select [From first Page] or [From second Page], and then press [OK].

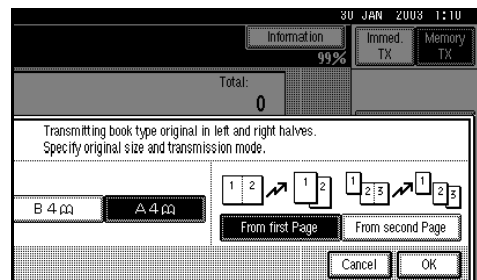

The selected original size is shown above the highlighted [Book Fax].

Note

- Select **[From first Page]** to send a book original from the first page.
- Select **[From second Page]** if you want to send a cover letter as the first page.

6 Press **[OK]**.

7 Dial, and then press the **[Start]** key.

Note

- When sending more than one page, place the originals individually, one after the other, pressing the **[Start]** key after each page.
- After the last original has been scanned, press **[#]**.
- If **[#]** is not pressed, the machine will automatically start sending the documents, 60 seconds after the last original has been scanned.

Two-Sided Transmission (Double-Sided Transmission)

The optional Auto Document Feeder (ADF) is required.

Use this function to send two-sided originals.

Note

- Originals placed on the exposure glass cannot be sent.

- The front and back of the scanned original will be printed in order on separate sheets at the other end. The orientation of alternate sheets may be reversed at the other end. If you want to print the original with the same orientation at the other end, specify the "Original Position" and "Page Opening Orientation".

	Original	Original position	Page opening orientation	Output at the other end
A3, B4, JIS, A4, 11" x 17", 8 1/2" x 14", 8 1/2" x 11"		↕	Top to Top	
			Top to Bottom	
		↕	Top to Top	
			Top to Bottom	
B5, JIS, A5, 8 1/2" x 5 1/2"		↕	Top to Top	
			Top to Bottom	
		↕	Top to Top	
			Top to Bottom	

GHPY020E

	Original	Original position	Page opening orientation	Output at the other end
A4, 8 1/2" x 11"		↕	Top to Top	
			Top to Bottom	
		↕	Top to Top	
			Top to Bottom	

GHPY030E

- This function is only available with Memory Transmission.
- This function is only available with the ADF.
- You can confirm whether both sides were properly scanned using the Stamp function. See p.66 "Stamp".

- You can program one of the Quick Operation keys with operations for this function. Using the key allows you to omit steps **2** and **3**.

- 1** Place the original in the ADF, and then select the scan settings you require.

Reference

p.11 "Placing Originals", *Facsimile Reference* <Basic Features>

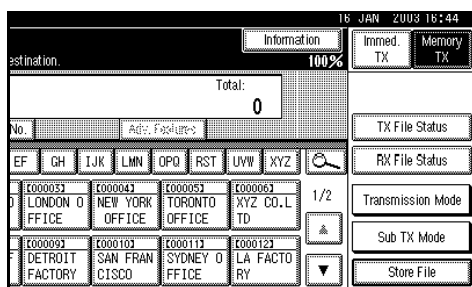

p.27 "Scan Settings", *Facsimile Reference* <Basic Features>

- 2** Press [Sub TX Mode].



- 3** Select [2 Sided Original].

- 4** Specify the original position.

Check the orientation of the placed document, and then press  or .

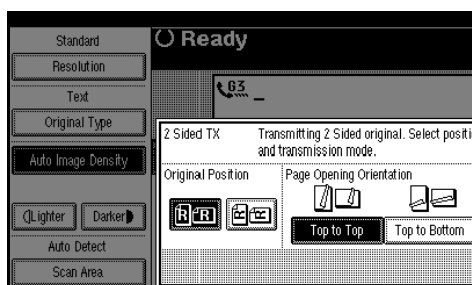

Note

- Make sure that the specified original position matches the orientation of originals loaded in the ADF.

- 5** Specify the page opening orientation from [Top to Top] or [Top to Bottom].

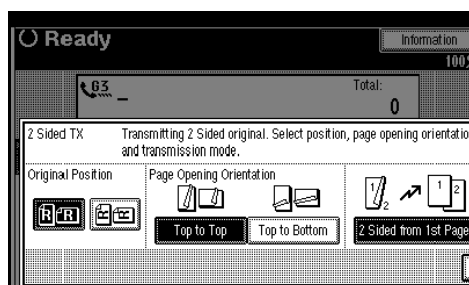

- 6** Specify the transmission mode from [2 Sided from 1st Page] or [1 Sided for 1st Page], and then press [OK].

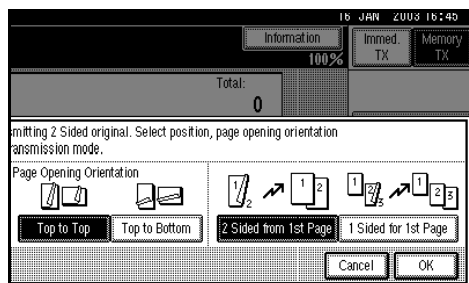

The selected original position and page opening orientation are shown above the highlighted [2 Sided Original].

Note

- To cancel this mode, press [Cancel]. The display returns to that of step **3**.
- Select [2 Sided from 1st Page] to send a two-sided original from the first page.
- Select [1 Sided for 1st Page] if you want to send a cover letter as the first page.

- 7** Press [OK].

- 8** Dial, and then press the [Start] key.

Standard Message Stamp

Use this function to stamp a standard message at the top of the first original sent.

There are four types of standard messages: “Confidential”, “Urgent”, “Please phone”, and “Copy to corres. section”

You can also program other messages.

Note

- While this function is in use, the third line of the Label Insertion is not printed. See p.70 “Programming the Label Insertion”.
- When there is an image around the area where the standard message is to be stamped, that image is deleted.
- To program a standard message, use the Program/Change/Delete Standard Message function. See p.137 “Programming, Changing, and Deleting Standard Messages”.

1 Place the originals, and then select the scan settings you require.

Reference

- p.11 “Placing Originals”, *Facsimile Reference* <Basic Features>
- p.27 “Scan Settings”, *Facsimile Reference* <Basic Features>

2 Press [Sub TX Mode].

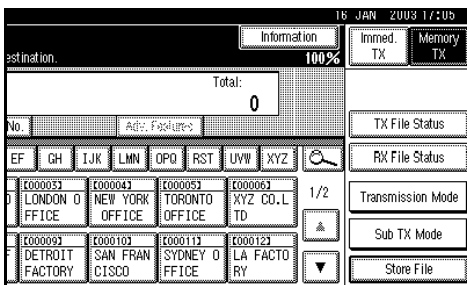

3 Select [Std. Message].

4 Select the standard message to be stamped, and then press [OK].

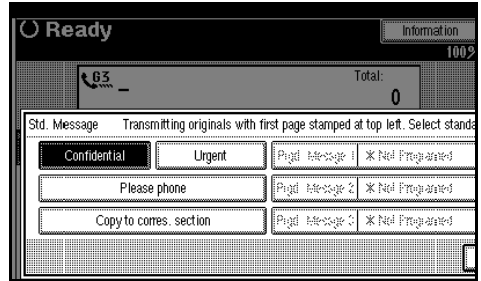

The selected standard message is shown above the highlighted [Std. Message].

Note

- To cancel the selection, press [Cancel]. The display returns to that of step 3.
- Programmed standard messages are shown in the keys.
- The machine cannot stamp multiple standard messages.

5 Press [OK].

6 Dial, and then press the [Start] key.

Sending an Auto Document

If you often send a particular page to people (for example a map, a standard attachment, or a set of instructions), store that page in memory as an Auto Document. This saves rescanning every time you want to send it.

You can fax an Auto Document by itself, or attach it to a normal fax message.

Preparation

You need to register an Auto Document. See p.138 “Storing, Changing, and Deleting an Auto Document”.

Note

- You can attach one Auto Document to each transmission.
- You can store up to 6 Auto Documents (up to 18 with the optional expansion memory installed). See p.138 “Storing, Changing, and Deleting an Auto Document”.
- Files with Auto Documents are sent by Memory Transmission.
- When sending an Auto Document with other files, the Auto Document is sent first.
- Storing Auto Documents reduces the amount of free memory slightly. Unless you delete the document, free memory will not return to 100%.
- You can print an Auto Document currently stored in memory. See p.60 “Printing documents stored as Auto Documents”.
- You can program one of the Quick Operation keys with operations for this function. Using the key allows you to omit steps 2 and 3.

- 1 Place the original, and then select the scan settings you require.

Reference

p.11 “Placing Originals”, *Facsimile Reference* <Basic Features>

p.27 “Scan Settings”, *Facsimile Reference* <Basic Features>

Note

- When you fax an Auto Document, start from step 2.

- 2 Press [Sub TX Mode].

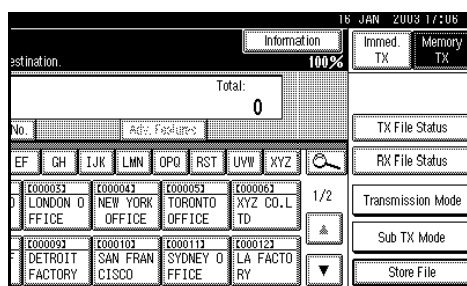

- 3 Select [Auto Document].

- 4 Select an Auto Document file, and then press [OK].

When you fax an Auto Document by itself, press [TX Stored File(AD) Only], and then press [OK].

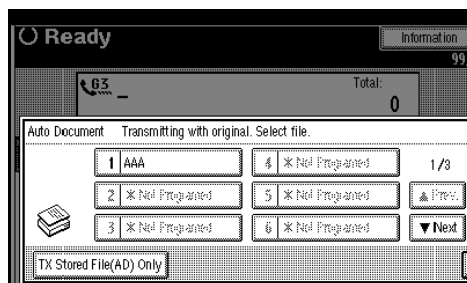

The selected file name is shown above the highlighted [Auto Document].

Note

- Programmed Auto Documents are shown in the keys.
- If you make a mistake, press **[Clear]** or the **[Clear/Stop]** key before pressing **[OK]**, and then try again.
- To cancel the Auto Document, press **[Cancel]**. The display returns to that of step **3**.

5 Press **[OK]**.

6 Dial, and then press the **[Start]** key.

Printing documents stored as Auto Documents

This function is used for printing documents stored as Auto Documents. This function is very convenient as it can be used for checking the contents of stored files.

1 Press **[Sub TX Mode]**.

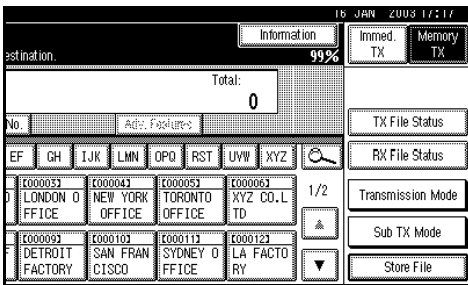

2 Select **[Auto Document]**.

3 Select an Auto Document file to be printed, and then press **[Print File]**.

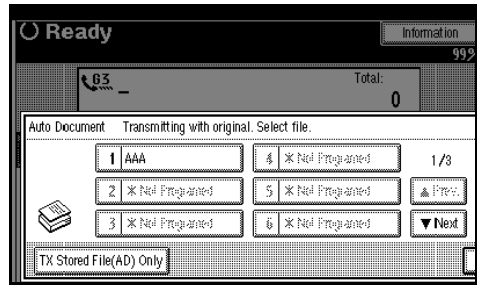

Note

- To cancel the Auto Document, press **[Cancel]** before pressing **[Print File]**. The display returns to that of step **2**.

4 Press the **[Start]** key.

Once printing is completed, the display returns to that of step **3**.

Note

- To cancel printing, press **[Cancel]**. The display returns to that of step **3**.

5 Press **[Cancel]**.

Note

- You can also send Auto Documents. See p.59 "Sending an Auto Document".

6 Press **[OK]**.

The standby display appears.

Sending a Stored File

Use this function to send documents stored in the Document Server. You can specify and send multiple documents, and also send them with scanned originals all at once.

You can also print stored originals with **[Print File]**. See p.64 "Printing stored documents".

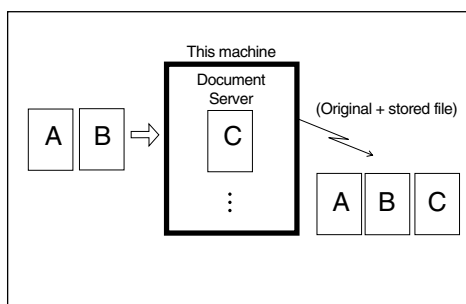

Preparation

Store the documents to be sent in advance. You can program a password for this function. You can change the user names, file names, and passwords of stored documents. See p.117 "Using the Document Server", and p.120 "File Manage".

Note

- Received fax documents are stored and categorized as "Stored RX Files". See p.30 "Printing/Deleting Received and Stored Documents (Printing Stored RX File)".
- You can program one of the Quick Operation keys with operations for this function. Using the key allows you to omit steps **1** and **2**.

Sending stored documents

The machine sends documents stored in the Document Server.

The documents stored in the Document Server can be sent again and again until they are deleted. Once sent, documents are stored in the Document Server. Therefore, you can send them in just one operation without having to set your originals again.

Limitation

- You cannot use the following transmission methods:
 - Free Polling Transmission
 - Default ID Transmission
 - ID Override Transmission
 - Immediate Transmission
 - Parallel Memory Transmission
 - On Hook Dial
 - Manual Dial

Note

- Only documents stored using the facsimile function can be sent. Documents stored using the copy, printer or scanner functions cannot be sent.
- You can specify and print multiple documents. You can specify a maximum of 30 documents at once.
- The machine can send a total of 1,000 pages in one operation.
- The specified documents are sent with the scan settings made when they were stored.

1 Press [Sub TX Mode].

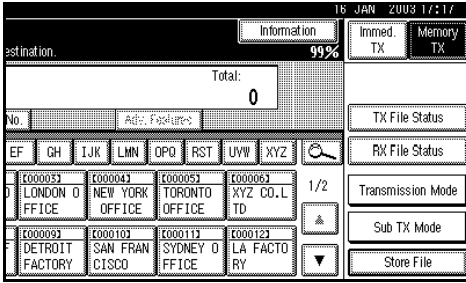

2 Select [Select Stored File].

3 Select the documents to be sent.

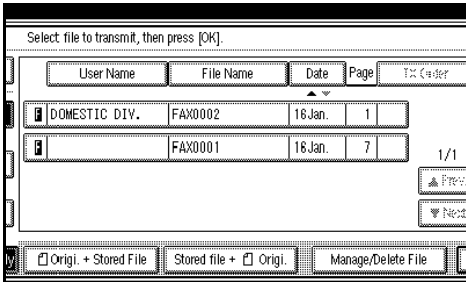

Note

- When multiple documents are selected, they are sent in the order of selection.
- Press [TX Order] to arrange the order of the documents to be sent.
- Press [File Name] to place the documents in alphabetical order.
- Press [User Name] to place the documents in order by registered user name.
- Press [Date] to place the documents in order of registered date.

Specifying documents from the file list

- 1** Press [▲ Prev.] or [▼ Next] to display the documents to be sent.
- 2** Select the file name.

Specifying documents from the User Name

1 Press [Search by User Name].

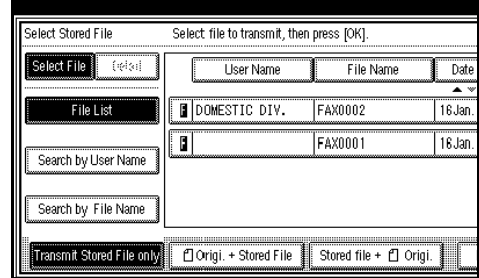

2 Select the user name of the registered document, and then press [OK].

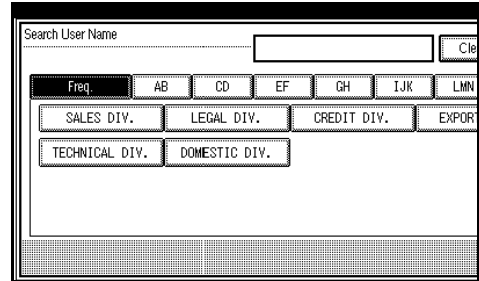

Note

- To search by user name, press [Non-programed Name], and then enter the user name. Partial matching is used when searching for a user name.

3 Select the file name to be sent.

Specifying documents from the file name

1 Press [Search by File Name].

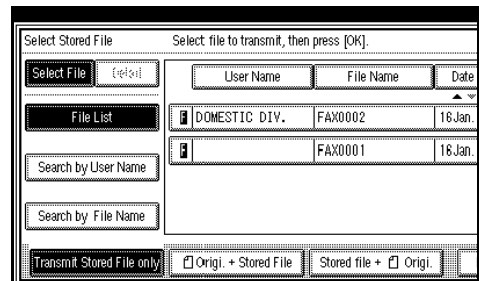

- 2 Enter the name of the document to be sent, and then press [OK].

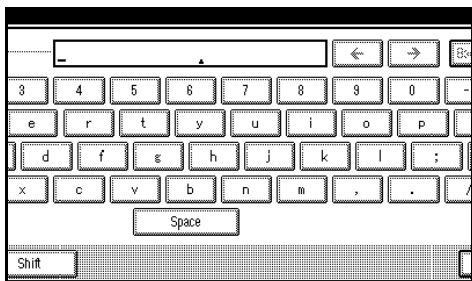

Note

- Partial matching is used when searching for a file name.

- 3 Select the file name to be sent, and then press [OK].

- 4 If you select a document with a password, enter the password, and then press [OK].

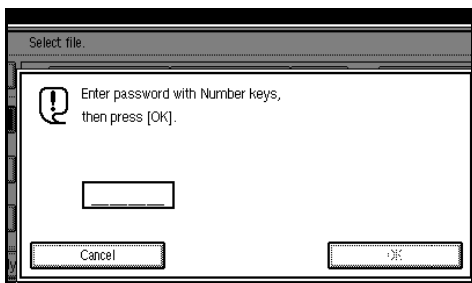

If the document does not have a password, proceed to step 5.

- 5 When you want to add your originals to stored documents and send them all at once, press [Origi. + Stored File] or [Stored file + Origi.].

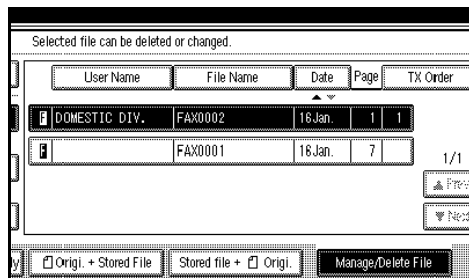

When sending only stored documents, proceed to step 6.

Note

- When [Origi. + Stored File] is pressed, the machine sends the originals and then stored files. When [Stored file + Origi.] is pressed, the machine sends the stored files and then originals.
- The added originals are not stored.

- 6 Press [OK] twice.

Note

- To add an original to stored documents, place the original, and then select any scan settings you require.

- 7 Dial, and then press the [Start] key.

Printing stored documents

Use this function to print documents stored in the Document Server.

Note

- ❑ Only documents stored using the facsimile function can be printed.
- ❑ You can print documents saved from the copy or the printer function with the Document Server. You cannot print documents saved from the scanner function with this mode.
- ❑ You can also print the first page only to check the content of the original.
- ❑ You can specify and print multiple documents. You can specify a maximum of 30 documents at one time.

1 Press [Sub TX Mode].

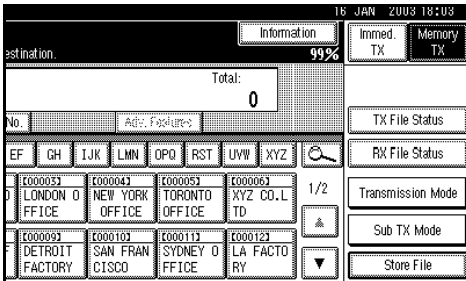

2 Select [Select Stored File].

3 Select the document to be printed.

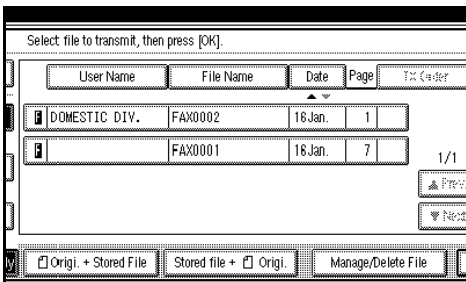

Note

- ❑ The documents stored using the facsimile function appear on the display.
- ❑ Press **[File Name]** to place the documents in alphabetical order.
- ❑ Press **[User Name]** to place documents in order of registered user name.
- ❑ Press **[Date]** to place the documents in order by the programmed date.
- ❑ To see details of the selected document, press **[Detail]**. To return to the standby menu, press **[File List]**.

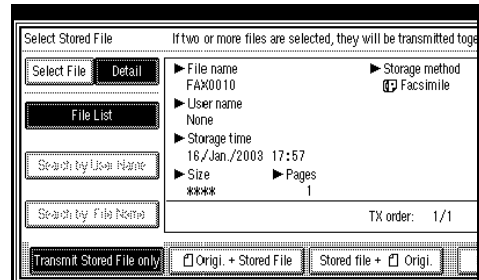

Selecting a document from file list

1 Press [▲ Prev.] or [▼ Next] to display the document to be sent.

2 Select the file name.

Specifying a document from the User Name

1 Press [Search by User Name].

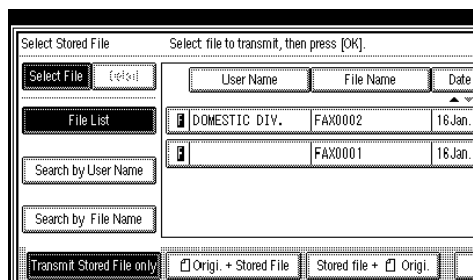

2 Press the user name of the document to be sent, and then press [OK].

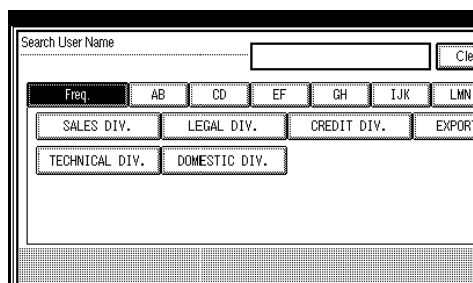

Note

- To search by user name, press **[Non-programed Name]**, and then enter the user name. User name serches using partial matching.

Reference

“Entering Text”, *General Settings Guide*

3 Select the file name.

Specifying a document from the file name

1 Press [Search by File Name].

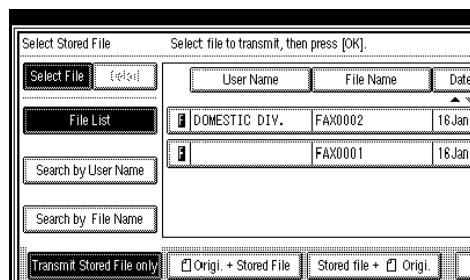

2 Enter the file name to be printed, and then press [OK].

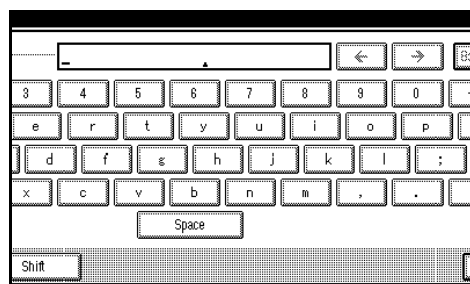

Note

- Partial matching is used to search for the file name.

Reference

“Entering Text”, *General Settings Guide*

3 Select the file name.

4 If you select a document with a password, enter the password, and then press [OK].

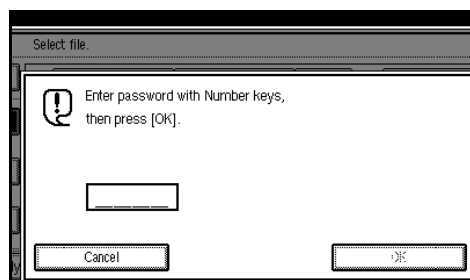

If the document does not have a password, proceed to step **5**.

5 Press **[Print File]** or **[Print 1st Page]**.

When **[Print File]** is pressed, the machine prints all the pages. When **[Print 1st Page]** is pressed, the machine prints only the first page.

Limitation

- When **[Print 1st Page]** is selected, originals larger than A4 size are printed after they are reduced to A4 size.
- The machine can print up to 30 files using the Print 1st Page function.

Note

- To print both sides, press **[Print 2 Sides]**.

6 Press the **[Start]** key.**Note**

- When only the first page is printed, the file name is printed at the top of the paper.
- To cancel printing, press **[Cancel]**.

7 Press **[Exit]**.**Note**

- You can also send a stored document. See p.61 "Sending stored documents".

8 Press **[OK]**.

The standby display appears.

Stamp

The optional Auto Document Feeder (ADF) is required.

When sending a fax message using the ADF, the machine can stamp a circle mark at the bottom of the original. When sending a two-sided document, the document is marked at the bottom of the front page and top of the rear page. This stamp indicates that the original has been successfully stored in memory for Memory Transmission, or successfully sent by Immediate Transmission.

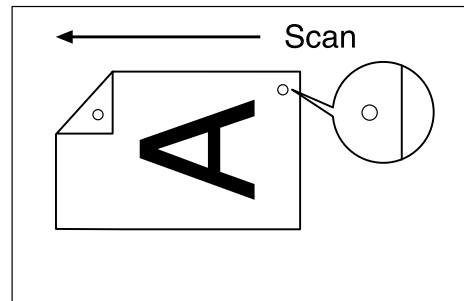

ZHPX020E

Note

- Stamp only works when scanning from the ADF.
- When the stamp starts getting lighter, replace the cartridge. See p.177 "Replacing the Stamp Cartridge".
- If a page was not stamped even though the Stamp function is turned on, you need to resend that page.

- ❑ If you use this function often, you can set the default in “General Settings/Adjustment” so that this function is always on. In this case, Stamp can easily be turned off for any single transmission by pressing **[Stamp]**. See p.130 “General Settings/Adjustment”. A paper jam during Parallel Memory Transmission may cause the transmission to be failed even if stamping is performed.
- ❑ You cannot turn the Stamp function on or off while a document is being scanned.

1 Place the original, and then select the scan settings you require.

Reference

p.11 “Placing Originals”, *Facsimile Reference* <Basic Features>

p.27 “Scan Settings”, *Facsimile Reference* <Basic Features>

2 Press **[Sub TX Mode]**.

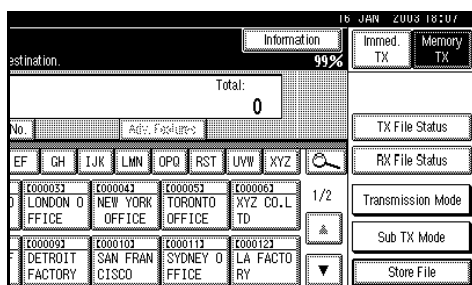

3 Select **[Stamp]**, and then press **[OK]**.

Note

- ❑ To cancel the stamp, press **[Stamp]** again before pressing **[OK]**.

4 Dial, and then press the **[Start]** key.

Transmission Options

This section describes various functions that you can switch on and off for any particular transmission, following the procedures given here.

In addition, if you frequently use a certain option configuration, you can change the default home position (on or off) of each option.

Fax Header Print

In some cases, you may want the other party to receive an unmarked copy of your original. To do this, switch Fax Header off.

When the Fax Header is set to “ON”, the stored name is printed on the receiver's paper.

You can store two Fax Headers; “First Name” and “Second Name”.

For example, if you store your department name in one and your organization name in the other, you could use the first when sending internal faxes and the second for external faxes.

Note

- ❑ If you used the number keys to specify the receiver, the first header name will be printed on the receiver's paper.
- ❑ You can program fax header names using the Program Fax Information function.
- ❑ You can select whether or not dates, fax header names, file numbers, or page numbers are printed by changing their respective user parameters.
- ❑ You can program one of the Quick Operation keys with operations for this function.

Label Insertion

With this function you can have the receiver name printed on the message when it is received at the other end. The name will be printed at the top of the page and will be preceded by "To". You can also cause the text programmed as a standard message to be printed. See p.137 "Programming, Changing, and Deleting Standard Messages".

 **Note**

- When there is an image around the area where the Label is to be printed, that image is deleted.
- You can program one of the Quick Operation keys with operations for this function.

Sender Stamp

When there is data, such as the user name and department name, programmed into the user code, you can have the machine print a sender stamp on the right edge of your paper.

 **Note**

- Enter the user name in System Settings.

Reduced Image Transmission

Using this function, your message is sent at a reduced size (93%) with a blank margin on the left.

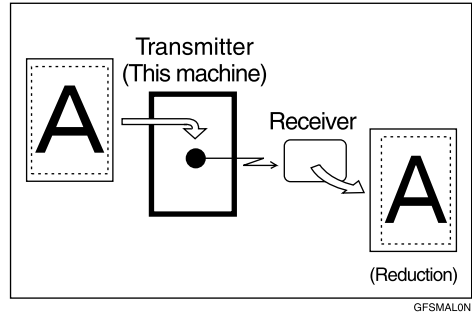

 **Note**

- This function is unavailable with Immediate Transmission, or specified transmission of a stored document.
- Image Rotation is unavailable with this function.

Auto Reduce

When this function is turned on, if the receiver's paper is smaller than the paper you are sending on, the message is automatically reduced to fit onto the paper available at the other end.

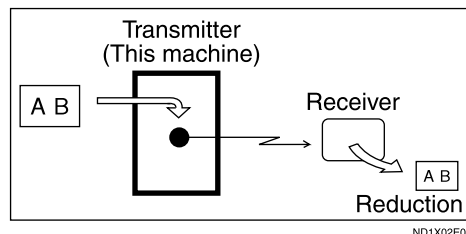

Important

- ❑ If you turn this function off, the scale of the original is maintained and some parts of the image may be deleted when printed at the other end.

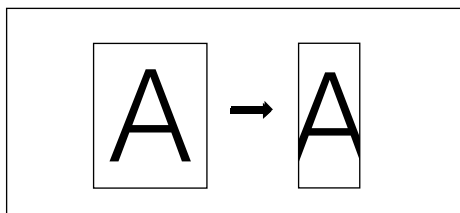

ND1X02E1

Default ID Transmission

If you turn this function on, transmission will only take place if the destination's Polling ID is the same as yours. This function can stop you accidentally sending information to the wrong place (you need to coordinate Polling ID's with the other party).

Note

- ❑ You can program one of the Quick Operation keys with operations for this function.

Selecting transmission options for a single transmission

- 1 Place the original, and then select the scan settings you require.

Reference

p.11 "Placing Originals", *Facsimile Reference* <Basic Features>

p.27 "Scan Settings", *Facsimile Reference* <Basic Features>

- 2 Press [Sub TX Mode].

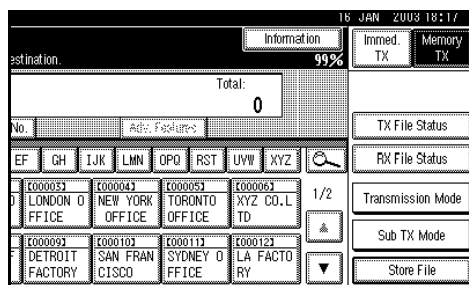

- 3 Select [Options].

- 4 Select options to be set up.

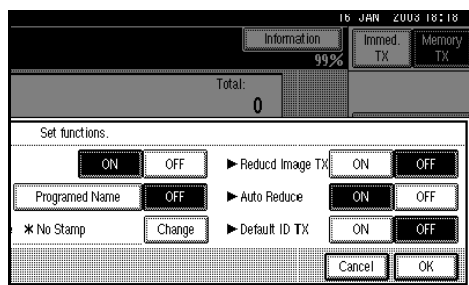
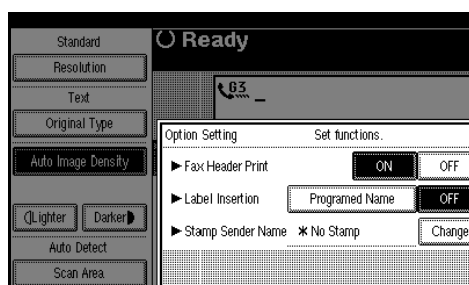

Note

- ❑ To close the option settings, proceed to step 5.

Programming the Fax Header Print

- 1 Press [ON] to specify the fax header print.

Note

- ❑ Press [OFF] if you do not want to print the sender name.

Programming the Label Insertion

- 1 Press **[Programed Name]** in “Label Insertion”.

Note

- Press **[OFF]** if you do not want to insert a destination.

Programming the Stamp Sender Name

- 1 Press **[Change]**.
- 2 Press the name of the user to be stamped, and then press **[OK]**.

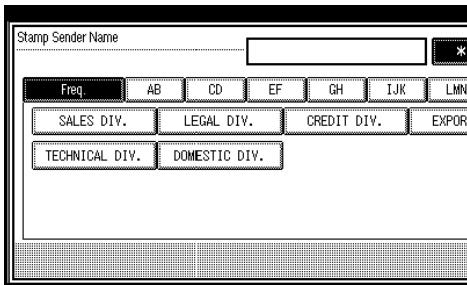

Note

- The set user name is displayed when the user code has been stored. See the *General Settings Guide*.
- You can switch titles by pressing the title keys.
- To stamp a non-registered user name, press **[Non-programed Name]**, and then enter the user name.
- If you do not want to stamp the sender's stamp, press **[No Stamp]**.

Programming the Reduced Image Transmission

- 1 Press **[ON]** in “Reduced Image TX”.

Note

- Press **[OFF]** if you do not want to do a reduced transmission.

Programming the Auto Reduce

- 1 Press **[ON]** in “Auto Reduce”.

Note

- Press **[OFF]** if you do not want to use the Auto Reduce function.

Programming the Default ID Transmission

- 1 Press **[ON]** in “Default ID TX”.

Note

- Press **[OFF]** if you do not want to use ID transmission.

- 5 Press **[OK]** twice.

- 6 Set the destination, and then press the **[Start]** key.

More Transmission Functions

If Memory Runs Out While Storing an Original

If you run out of memory while storing an original (free space reaches 0%), the message "Memory is full. Cannot scan more. Transmission will be stopped." is displayed.

Press **[Exit]** to transmit stored pages only.

Note

- In default, scanned pages are sent. To change the settings to delete scanned pages, contact your service representative.

Parallel Memory Transmission

This function dials while the original is being scanned. Standard Memory Transmission stores the original in memory, then dials the destination. Parallel Memory Transmission allows you to quickly determine whether a connection was made. In addition, this function scans the original faster than Immediate Transmission. This is useful when you are in a hurry and need to use the original for another purpose.

Limitation

- Standard Memory Transmission is used instead of Parallel Memory Transmission in the following cases:
 - When the line is busy and could not be connected to
 - With Send Later

- When you store an original for Memory Transmission while another communication is in progress
- When two or more destinations are specified
- When you send only an Auto Document
- When the first page of an original is placed on the exposure glass
- When you send messages stored in the Document Server

Note

- You can turn this function on or off with the User Parameters. See p.147 "Changing the User Parameters" (switch 07, bit 2).
- Standard Memory Transmission may be used instead of Parallel Memory Transmission depending on the optional equipment installed if there is not enough free memory left.
- If you use this function, the Memory Storage Report will not be printed.
- If the **[Clear/Stop]** key is pressed, an original will jam or memory will run out during Parallel Memory Transmission stops. The Transmission Result Report is printed and files are deleted.
- When Parallel Memory Transmission is used, the total number of originals in "Fax Header Print" is not automatically printed.

Checking the Transmission Result

- Turn the Transmission Result Report on if you want a report to be printed after every successful transmission. See p.18 “Memory Transmission”, *Facsimile Reference <Basic Features>*.
- If you leave the Transmission Result Report off, the report will not be printed after every transmission. However, if a transmission fails, a Communication Failure Report will be printed instead. See p.75 “Communication Failure Report”.
- You can also check the transmission result by examining the Journal. See p.23 “Printing the Journal”.
- You can either print or scroll through the Journal on the display. See p.27 “Checking the Transmission Result (TX File Status)”.

Automatic Redial

If a fax message could not be transmitted because the line was busy or an error occurred during transmission, redialing is done five times in five minutes intervals (these figures vary according to which country you are in).

If redialing fails after four redials, the machine cancels the transmission and prints a Transmission Result Report or Communication Failure Report.

Batch Transmission

If you send a fax message by Memory Transmission and there is another fax message waiting in memory to be sent to the same destination, that message is sent along with your original. Several fax messages can be sent with a single call, thus eliminating the need for several separate calls. This helps save communication costs and reduce transmission time.

Fax messages for which the transmission time has been set in advance are sent by batch transmission when that time is reached.

 **Note**

- You can turn this function on or off with the User Parameters. See p.147 “Changing the User Parameters” (switch 14, bit 2).
- The originals to be transmitted at a specific time will be sent at that time.
- If fax memory is overloaded, messages may not be sent in the order they were scanned.

ECM (Error Correction Mode)

This function automatically sends data that was not transmitted successfully using a system that complies with international standards.

ECM requires that the destination machine has the same function.

 **Note**

- You can turn this function on or off using the Key Operator Settings. See p.146 “ECM”.

Broadcasting Sequence

If you dial several destinations for the same message (broadcasting), the messages are sent in the order in which they were dialed. If the fax message could not be transmitted, the machine redials that destination after the last destination specified for broadcasting. For example, if you specify four destinations, A through D, for broadcasting, and if the lines to destinations A and C are busy, the machine dials the destinations in the following order: A, B, C, D, A, and C.

Checking the Transmission Progress

To check which destinations the fax message has been sent to so far, print the TX file list.



Dual Access

The machine can scan other messages into memory even while sending a fax message from memory, receiving a message into memory, or automatically printing a report. Since the machine starts sending the second message immediately after the current transmission ends, the line is used efficiently.

Note

- Note that during Immediate Transmission or when in User Tools mode, the machine cannot scan an original.

Transmission with Image Rotation

Generally, place A4, 8¹/₂"×11" originals in the landscape orientation () . If you place an A4, 8¹/₂"×11" original in the portrait orientation () , the image will be sent rotated by 90°. Providing the receiver has A4, 8¹/₂"×11" landscape paper () , the message will be printed the same size as the original.

Note

- This function is unavailable with Immediate Transmission.
- When Image Rotation is used, all messages are sent by normal Memory Transmission.
- This function is unavailable when using Mixed Original Sizes.

Simultaneous Broadcast

The optional extra G3 interface unit is required.

The Standard Broadcast function sends faxes one at a time to multiple destinations in the order of specified destination numbers.

The Simultaneous Broadcast function, however, can simultaneously send faxes to three destinations using different lines.

This results in a shorter overall transmission time.

- ❑ If ECM is turned off, JBIG Transmission is unavailable. See p.146 “ECM”.

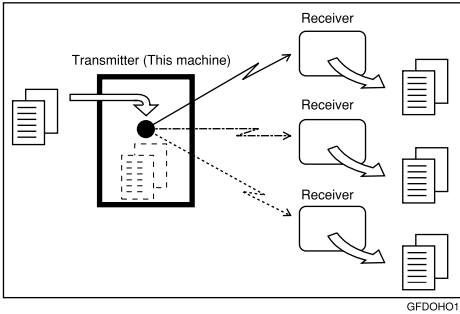

Note

- ❑ This function can use a maximum of three lines simultaneously.
- ❑ When using the optional extra G3 interface unit, if you set the line selection as “G3 Auto” beforehand, the machine will use whichever G3 line is not busy. This increases efficiency.

JBIG Transmission

The optional fax function upgrade unit is required.

If you use JBIG (Joint Bi-level Image Experts Group) compression, you can send photographic originals faster than with other methods of compression. You can only use this function with G3 line type.

Limitation

- ❑ This function requires that the other party's fax machine has both the JBIG function and ECM function (G3 communication only).

Note

- ❑ When the optional extra G3 interface unit is installed, JBIG receptions of G3-2 and G3-3 lines are standard.

Printed Report

Memory Storage Report

This report is printed after an original is stored in memory. It helps you review the contents and the destinations of stored originals. Even if the machine is set up not to print this report, it is still printed if an original could not be stored.

Note

- You can turn this report on and off. See p.147 “Changing the User Parameters” (switch 03, bit 2).
- You can select whether to include part of the original image on the report. See p.147 “Changing the User Parameters” (switch 04, bit 7).
- If you use Parallel Memory Transmission, the Memory Storage Report is not printed.

Transmission Result Report (Memory Transmission)

This report is printed when a Memory Transmission is completed, so you can check the result of the transmission. If two or more destinations are specified, this report is printed after the fax message has been sent to all the destinations. If the machine is set up not to print this report and the fax message could not be successfully transmitted, a Communication Failure Report is printed. See p.75 “Communication Failure Report”.

Note

- You can turn this function on or off with the User Parameters. See p.147 “Changing the User Parameters” (switch 03, bit 0).
- You can select whether to include part of the original image on the report. See p.147 “Changing the User Parameters” (switch 04, bit 7).
- The Page column gives the total number of pages. The Not Sent column gives the number of pages that could not be sent successfully.

Communication Failure Report

This report is only printed if the Transmission Result Report is turned off and a message could not be successfully transmitted with Memory Transmission. Use it to keep a record of failed transmissions so you can send them again.

Note

- You can select whether to include part of the original image on the report. See p.147 “Changing the User Parameters” (switch 04, bit 7).
- The Page column gives the total number of pages. The Not Sent column gives the number of pages that could not be sent successfully.

Transmission Result Report (Immediate Transmission)

If you turn this report on, a report will be printed after every Immediate Transmission so you have a record of whether the transmission was successful or not. If the machine is set up not to print this report and the fax message could not be successfully transmitted, the Error Report is printed instead.

4

Note

- You can switch this report on or off in the User Parameters. See p.147 “Changing the User Parameters” (switch 03, bit 5).
- If the page was sent successfully, the Page column gives the total number of pages sent successfully.

5. Reception Features

Reception

Immediate Reception

Each page of a fax message is printed as soon as it is received. This method is used for standard fax messages.

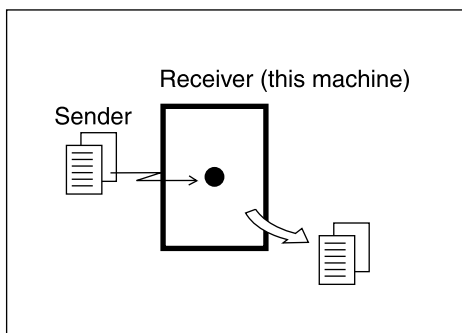

Normally this machine receives messages by Immediate Transmission. But Memory Reception is used when "Combine 2 Originals", "Multi-copy reception", "Reverse Order Printing reception" or "Two-sided Printing" is set to "ON". See p.84 "Printing Options". If the conditions are that Substitute Reception should be used, a fax message is not printed. It will be stored in memory. See p.77 "Memory Reception". See p.79 "Substitute Reception".

Note

- The machine may not be able to receive fax messages when free memory space is low.
- If free memory reaches 0% during Immediate Reception, any further reception becomes impossible and the current communication is terminated.

Reception resolution

This machine supports Standard, Detail, and Super fine resolutions for reception. If you do not have the optional fax function upgrade unit, faxes sent at Super fine resolution will be printed on your machine at Detail resolution. This may differ from the sender's intended resolution.

Memory Reception

The machine waits until all pages of the message have been received into memory before printing it.

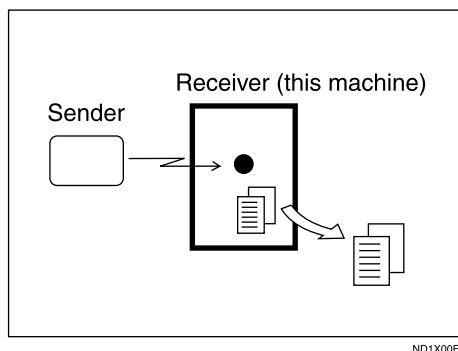

This method is used with the following functions:

- Combine 2 originals
See p.87 "Combine Two Originals".
- Multi-copy when set to multiple copies
See p.86 "Multi-copy Reception".
- Reverse Order Printing
See p.88 "Reverse Order Printing".
- 2-sided Printing
See p.85 "Two-Sided Printing".

 **Important**

- When about one hour passes after power to the machine is turned off, all fax messages stored in memory will be lost. If any messages have been lost for this reason, a Power Failure Report is automatically printed when the operation switch is turned on. Use this report to identify lost messages.
- The machine may not be able to receive large numbers of messages or messages with high data content. In such cases, we recommend you switch off the above functions or install the optional expansion memory.

5

 **Limitation**

- The machine may not be able to receive fax messages when free memory space is low.

 **Note**

- If the free memory space reaches 0% during Memory Reception, the machine can no longer receive the current fax message and stops communicating.
- If you have selected **[Store]** for **[Reception File Setting]**, received messages will be saved on the hard disk and will not be printed. You can print those messages by operating the machine or a connected computer, as necessary. See p.172 "Storing or Printing Received Documents".

Substitute Reception

In Substitute Reception, a received fax message is stored in memory instead of being printed. Substitute Reception gets used when the machine cannot print any fax messages. Fax messages received using Substitute Reception are automatically printed when the condition which caused the machine to use Substitute Reception is rectified.

Depending on why the machine cannot print, Substitute Reception might be used for all fax messages received, or for only those messages that match a specified condition.

The Receive File indicator lights to let you know when fax messages have been received using Substitute Reception.

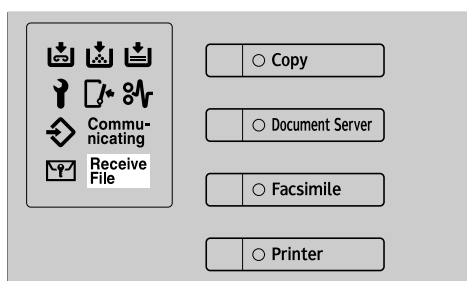

ZHPS280E

Note

- ❑ Reception may not take place if there is not enough free memory.
- ❑ If free memory reaches 0% during Substitute Reception, any further reception becomes impossible and the current communication is terminated.
- ❑ When a fax message is received after **[Store]** has been selected for **[Reception File Setting]** in the Facsimile Features menu, the Receive File indicator lights.





Receiving messages unconditionally

If one of the conditions listed below occurs, the machine receives all fax messages using Substitute Reception.

Problems	Causes	Solutions
⚠ is lit.	Paper is jammed.	Remove the jammed paper. See "⚠Cleaning Misfeeds", <i>General Settings Guide</i> .
The machine is printing with other function.	The machine is busy printing with other function.	The message will be automatically printed after the current job finishes.
The message "Following output tray is full. Remove paper." appears.	The output tray is full.	Remove paper from the output tray.
📄 is lit.	The cover is open.	Close the cover shown in the display.

Receiving messages according to parameter-specified settings

If one of the conditions listed below occurs, the machine receives only those messages that match the conditions specified in the User Parameters. See p.147 “Changing the User Parameters” (switch 05, bit 2,1).

Problems	Causes	Solutions
 is lit.	All trays out of paper.	Add paper. See “  Loading Paper”, <i>General Settings Guide</i> .
 is lit.	Toner is empty.	Replace the toner cartridge. See “  Adding Toner”, <i>General Settings Guide</i> .
The message “This tray is out of order.” appears.	All trays out of action.	Call your service representative.

You can specify the following conditions with the User Parameters. See p.147 “Changing the User Parameters” (switch 05, bit 2,1).

5

❖ **When Own Name or Own Fax Number is received**

The machine switches to Substitute Reception only when the sender has programmed their Own Name or Own Fax Number. If the power is switched off for more than an hour, all the messages stored in memory are deleted. In that case, the Power Failure Report or the Journal can be used to identify which messages are lost so you can ask the senders to transmit them again.

 **Important**

If a sender has not programmed their Own Name or Own Fax Number, the machine may fail to receive an important fax message. We recommend that you ask important senders to program an Own Name or Own Fax Number in advance.

❖ **Free**

The machine switches to Substitute Reception regardless of whether or not the sender has programmed their Own Name or Own Fax Number.

❖ **Polling ID match**

The machine switches to Substitute Reception only when the programmed Polling ID of the other end matches the ID of this machine.

❖ **Disable**

The machine does not receive any messages.

Reception Functions

Transfer Station

Transfer Stations allow you to expand the standard functions of your fax machine to set up complex networks. The diagram below may make the concept clearer.

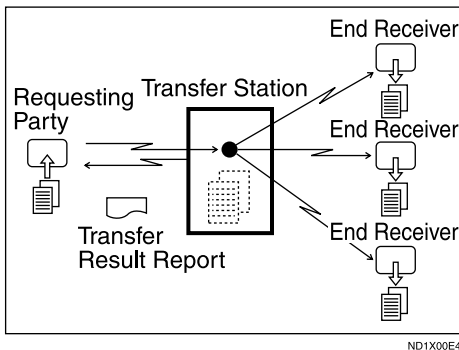

The following terminologies are used in this section:

❖ Requesting Party

The machine where the message originates.

❖ Transfer Station (this machine)

The machine that forwards the incoming message to another destination.

❖ End Receiver

The final destination of the message, that is the machine the Transfer Station sends to. End Receivers must be programmed into a Quick Dial or Groups in the Transfer Station.

! Limitation

- ❑ Polling ID's of the Requesting Party and Transfer Station must be identical for this function to work.

- ❑ A Transfer Request cannot be sent if the fax number of the transfer station (this machine) is not programmed as a Quick Dial.
- ❑ If your line number is not registered at the Transfer Station, reception will not take place. See p.169 "Transfer Report".
- ❑ If the Requesting Party specifies a Group for the End Receivers and the total number of End Receivers exceeds 500, the Transfer Station cannot transfer the message and sends a Transfer Result Report to the Requesting Party.
- ❑ See "Registering Destination to a Group", *General Settings Guide*.

💡 Multistep transfer

The principles of Transfer Stations can be used to build up a multi-step facsimile network where messages are passed through several Transfer Stations. By programming the End Receivers in a Transfer Station Group, you can enable this machine to transfer messages onto other Transfer Stations.

For more information, contact your service representative.

This function can only be used if the machines are made by the same manufacturer.

 **Sending the transfer result report**

This machine compares the fax number of the Requesting Party with the Requesting Party's number programmed as a Quick Dial or Speed Dial. If the lower five digits of the two numbers match, it sends the Transfer Result Report to the Requesting Party.

For example:

- Requesting Party's own dial number:
001813-11112222
- Transfer Station's Quick Dial:
03-11112222

Transfer result report

This reports whether transmission to the End Receivers was successful or not.

 **Preparation**

Program the Requesting Party fax number into a Quick Dial key in advance.

Program your own fax number. See p.169 "Transfer Report".

Program the Polling ID. See p.170 "Programming a Polling ID".

When the Transfer Station has transferred the message to all End Receivers, it sends the Transfer Result Report back to the Requesting Party. The machine prints the report if it cannot be sent back to the Requesting Party. You must program the fax number of the Requesting Party as a Quick Dial in the Transfer Station.

 **Note**

- You can set whether a portion of the original image is printed on the report with the User Parameters. See p.147 "Changing the User Parameters" (switch 04, bit 7).

JBIG Reception

The optional fax function upgrade unit is required.

If you use JBIG (Joint Bi-level Image Experts Group) compression, you can send photographic originals faster than with other methods of compression. You can only use this function with G3 line type. It allows you to receive messages sent in the JBIG format through JBIG Transmission.

 **Limitation**

- If ECM is turned off, JBIG Reception is unavailable.

 **Note**

- When the optional extra G3 interface unit is installed, JBIG receptions of G3-2 and G3-3 lines are as standard.

Auto Fax Reception Power-up

This machine can be set to shut down automatically if no one has used it for a while. In these situations, even though the operation switch is off, the machine can still receive incoming messages as long as the main power switch is on.

Important

- Reception is not possible if both the operation switch and main power switch are turned off.

Note

- You can set whether messages are printed as soon as they are received (Immediate Reception) with the User Parameters. See p.147 “Changing the User Parameters” (switch 14, bit 0).
- You can also have fax messages received by Memory Reception (Substitute Reception) printed after the machine is turned on.

Printing Options

Print Completion Beep

When this function is turned on, the machine beeps to let you know when a received message has been printed.

Note

- You can alter the volume of the beep or turn it off completely (set the volume to the minimum level). See p.49 “Adjusting the Volume”, *Facsimile Reference <Basic Features>*.

5

Checked Mark

When this function is turned on, a Checkered Mark is printed on the first page of fax messages to help you separate them.

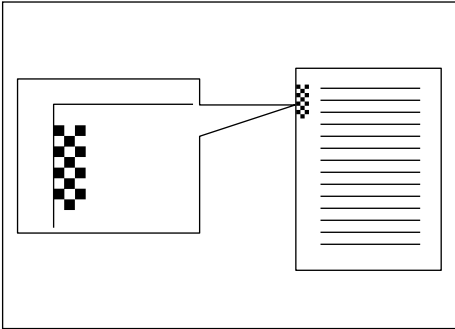

Note

- You can turn this function on or off using Reception Setting. See p.132 “Reception Setting”.

Center Mark

When this function is turned on, marks are printed halfway down the left side and at the top center of each page received. This makes it easy for you to position a hole puncher correctly when you file received messages.

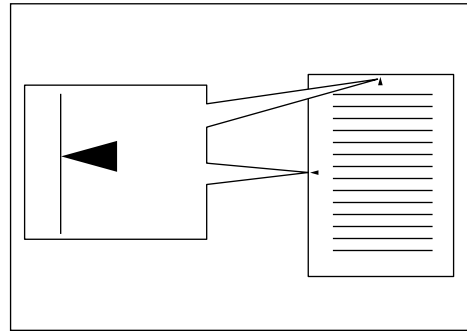

Note

- The Center Mark may deviate a little from the exact center of the edge.
- You can turn this function on or off using Reception Setting. See p.132 “Reception Setting”.

Reception Time

You can have the date and time printed at the bottom of the message when it is received. You can turn this function on or off using Reception Setting. See p.132 “Reception Setting”.

Note

- ❑ When a received message is printed on two or more sheets, the date and time is printed on the last page.
- ❑ The date and time when the message was printed can also be recorded on the message. If you need this function, contact your service representative.

Two-Sided Printing

The optional duplex unit is required.

You can have a received message printed on both sides of a sheet. You can turn this function on or off using Reception Setting. See p.132 “Reception Setting”.

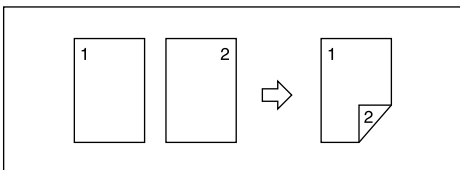

Limitation

- ❑ To use this function, all pages of the received document must be of the same size—inform the sending party of this beforehand if necessary. You must also have paper set in your machine of the same size as that sent by the sending party. In Two-Sided Printing, this machine will correctly receive in A3, B4 JIS (Japanese Industrial Standard), A4, B5 JIS, A5 (11"×17", 8 1/2"×14", 8 1/2"×11", 8 1/2"×5 1/2"). The following table shows the results that can be achieved when receiving with this machine.

	Originals	Top binding	Side binding
A4, B5 JIS, A5, 8 1/2" × 11", 8 1/2" × 5 1/2"			
A3, B4 JIS, 11" × 17", 8 1/2" × 14"			

ND0X03N3

- ❑ This function works only when all pages are of the same width and received into memory.
- ❑ This function cannot be used with Combine two originals.

Note

- The machine will use Memory Reception for Two-Sided Printing.
- Printouts may vary depending on how the sender sets the originals.
- You can select to have messages only from selected senders printed in this way. See p.152 “Special Senders to Treat Differently”.
- Stored documents of the same size are printed on the same paper. Some stored documents may be unavailable for this printing option.

180-Degree Rotation Printing

When printing on both sides of the paper, this machine rotates images as shown in the diagram.

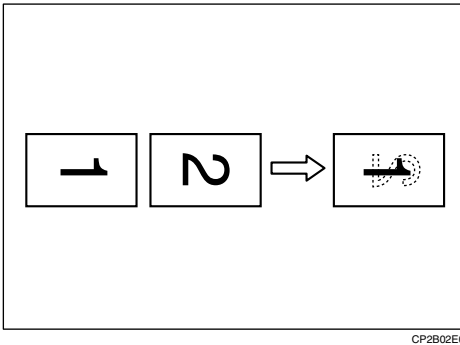

Multi-copy Reception

If you switch this function on, multiple copies of each incoming fax message will be printed. You can also select to have multiple copies made of messages from particular senders. See p.152 “Special Senders to Treat Differently”. See p.132 “Reception Setting”.

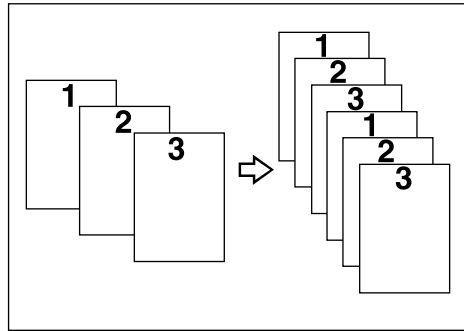

Note

- The maximum number of copies that can be made for each message is 10.
- When you are using the Multi-Copy function with specified senders, the maximum number of copies is 10.
- You can turn this function on or off using Reception Setting. See p.132 “Reception Setting”.
- The machine will use Memory Reception for Multi-copy Reception.

Image Rotation

If you have set paper in the standard tray , incoming fax messages will be rotated automatically to fit onto the paper.

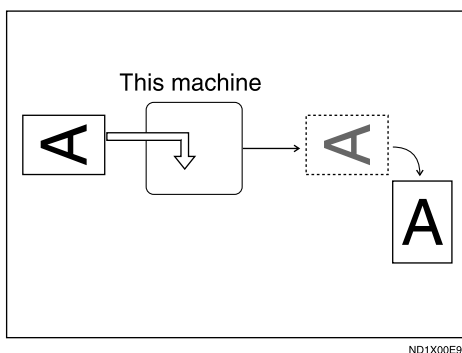

Note

- You can choose to have received messages printed from a specified tray. See p.132 “Reception Setting”.

Combine Two Originals

When two messages of the same size and orientation are received consecutively, they are printed on a single sheet when you turn this function on. This can help you economize on paper.

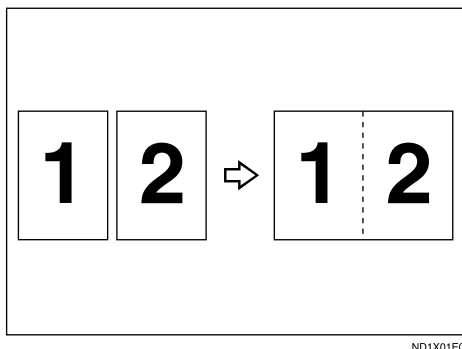

- Two A5 messages are printed side by side on a sheet of A4 .

- Two B5 JIS messages are printed side by side on a sheet of B4 JIS .
- Two A4 messages are printed side by side on a sheet of A3 .
- Two 8 1/2"×5 1/2" messages are printed side by side on a sheet of 8 1/2"×11" .
- Two 8 1/2"×11" messages are printed side by side on a sheet of 11"×17" .

Limitation

- This function does not work with messages larger than A5 , B5 JIS , A4 , 8 1/2" × 11" or 8 1/2" × 5 1/2" . When A5 , B5 JIS , A4 , 8 1/2" × 11" or 8 1/2" × 5 1/2" size paper is loaded in the machine, each page of the received message is printed on a single sheet.
- If paper matching the size and orientation of a received document is unavailable, “Combine two originals” is not possible.
- When [**Combine two originals**] and [**2-Sided Printing**] are selected at the same time, [**Combine two originals**] takes priority and [**2-Sided Printing**] is canceled.

Note

- You can turn this function on or off with the User Parameters. See p.147 “Changing the User Parameters” (switch 10, bit 1).
- This function uses Memory Reception.

Page Separation and Length Reduction

When the size of a received message is longer than the paper loaded in the machine, each page of the message can be split and printed on several sheets, or reduced and printed on a single sheet. For example, this function splits the message if the message length is 20 mm (0.79") or longer than the paper used. The message is reduced if it is less than 20 mm (0.79"). When a message is split, an asterisk (*) is inserted at the split position and about 10 mm (0.39") of the split area is duplicated on the top of the second sheet.

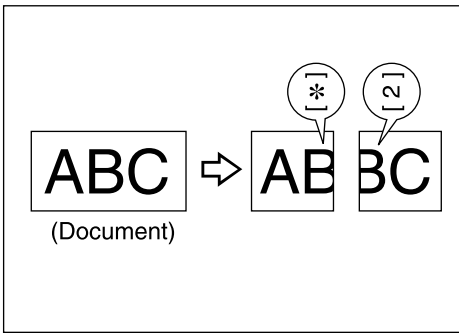

Note

- Your service representative can customize this function with the following settings:
 - Reduction
 - Print split mark
 - Overprinting
 - Overprinting length
 - Guideline for split
- You can adjust the overprinting and reduction lengths within the following ranges:
 - Overprinting length: 4 mm (0.16"), 10 mm (0.39"), 15 mm (0.59")
 - Guideline for split: 5-155 mm (5 mm steps)/0.2"-6.1" (0.2" steps)

Reverse Order Printing

Normally, received pages are printed and stacked on the tray in the order they are received. If you turn this function on, the machine will start printing the message from the last page received.

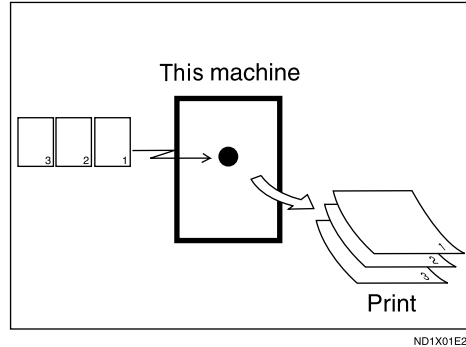

Note

- You can turn this function on or off using Reception Setting. See p.132 "Reception Setting".
- When this function is on, the first page will be printed last.
- This function uses Memory Reception.

Page Reduction

If you receive a message that is longer than the paper in the cassette, the machine usually prints it on two pages. If you turn this function on, the machine reduces the width and length of the received image so that it will fit on one page. If A4 paper is loaded and a message of B4 JIS size is received, the machine will reduce the message to a single A4 sheet.

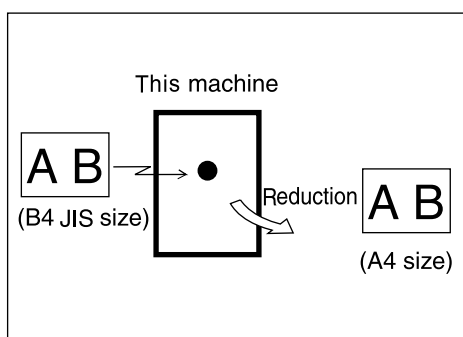

ND1X01E3

Note

- You can turn this function on or off with the User Parameters. See p.147 "Changing the User Parameters" (switch 10, bit 3).
- When this function is used, the printing quality may not be as good as usual.

Reference

p.88 "Page Separation and Length Reduction"

TSI Print (Transmitting Subscriber Identification Print)

Usually the sender's Fax Header is printed on received messages. If the sender has not programmed their Fax Header, you will not be able to identify them. However, if you turn this function on, the sender's Own Name or Own Fax Number is printed instead so you can find out where the message came from. See p.41 "Initial Settings and Adjustments", *Facsimile Reference* <Basic Features>.

Note

- You can turn this function on or off in the User Parameters. See p.147 "Changing the User Parameters" (switch 02, bit 3).

When There Is No Paper of the Correct Size

If there is no paper in your machine that matches the size of a received message, the machine will choose a paper size based on the paper available. For example, if your machine has 8¹/₂"×11" and A3 loaded and you receive a A4 size message, check the A4 column of the following table. The paper size at the top has highest priority. In this case, since 8¹/₂"×11" is given a higher priority than A3 , the message is printed on 8¹/₂"×11" .

If only B5 JIS is loaded and you receive an A3 message, the received message is stored in memory and not printed.

◆ Priority Table

		Received Image Size						
		A3,DLT	B4 JIS	A4,LT	A4,LT	B5 JIS	LG	F/F4
Paper Select Priorities	1	A3	B4 JIS	LT	A4	B5 JIS	LG	F/F4
	2	DLT	A3	LT	A4	B5 JIS	A4	LG
	3	A4	DLT	A4	LT	B4 JIS	A4	A4
	4	A4	B5 JIS	A4	LT	A4	LT	A4
	5	LT	B5 JIS	F/F4	A3	A4	LT	LT
	6	LT	A4	LG	F/F4	LT	F	LT
	7	F/F4	A4	A3	DLT	LT	B4 JIS	B4 JIS
	8	B4 JIS	LT	B4 JIS	B4 JIS	F/F4	A3	A3
	9	LG	LT	DLT	LG	A3	DLT	DLT
	10		F/F4	HLT		DLT	HLT	HLT
	11		LG	A5		LG	A5	A5

- Portrait
- Landscape
- Image Rotation

GFPR100E

Page reduction	Disabled
Reduction in Sub-scan Direction	Enabled
Page Separation Threshold	20 mm (0.79")
Width or Length Priority	Width

- and indicate that the message is split over two pages of paper with the orientation and size shown.

Note

- Paper placed in the bypass tray is not usually selected for printing a received message. However, you can use this tray if you select the bypass tray as the main paper tray using Reception with Specified Senders. See p.152 "Special Senders to Treat Differently".
- Widths that this machine can receive are A4, B4 JIS, and A3. Any messages narrower than A4 are sent as A4 width with the length unchanged.

- The paper size used to print a received message may be different from the size of the sent original.
- If you specify a receiving tray with the setting priority under System Settings, the messages may be received in a different order by setting the priority table. The priority tray may be used only when the document received is the same size as the priority tray.

Reference

- p.88 "Page Separation and Length Reduction"
- p.89 "Page Reduction"
- p.87 "Image Rotation"

Just Size Printing

If you turn this function on and no paper tray is stocked with paper of a suitable size to print a received document, a message will appear on the display prompting you to load paper of the required size. When you have loaded new paper, you can then print the message.

Two messages can appear:

- Paper Cassette

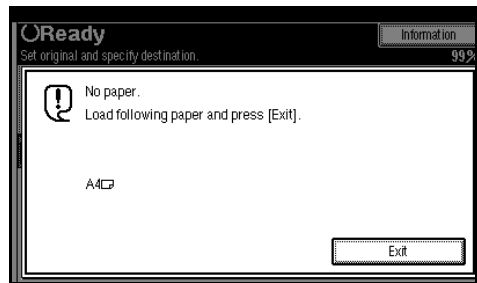

- Bypass Tray

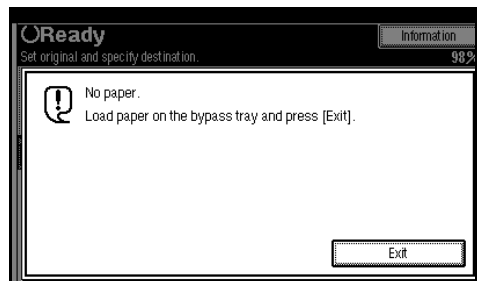

! Limitation

- ❑ If the paper tray is pulled out or the machine runs out of the specified size of paper, the message will not be printed. Be sure the paper tray is inserted.
- ❑ The action that follows pressing **[Exit]** varies depending on the status of the machine when the message occurred.
 - If any received documents or reports were being printed automatically, the printer automatically continues printing from where it left off.
 - If any documents or reports were being printed manually, the printer does not resume printing. Perform the operation from the beginning again.

✎ Note

- ❑ You can turn this function on or off with the User Parameters. See p.147 “Changing the User Parameters” (switch 05, bit 5).

Setting Priority Trays

With the same size of paper loaded into multiple trays, you can make the machine use one tray for one function and another tray for another function. For example, you may load white A4 paper into tray 1 to use when making copies, and yellow A4 paper into tray 2 to use when printing received faxes. You can then easily identify for which purpose paper has been output. You can perform this setting using System Settings. See the *General Settings Guide*.

✎ Note

- ❑ When a different size of document from the priority tray is received, the tray containing the same size of paper as the received document is used.

Having Incoming Messages Printed on Paper from the Bypass Tray

You can have messages sent from Specified Senders printed on paper from the bypass tray. This is useful if you need messages printed on a size of paper not stocked in the paper cassette(s).

You can load a maximum of 100 sheets of standard paper in the bypass tray.

✎ Note

- ❑ Before you can use this function, you need to turn on Authorized Reception (Initial Setup Reception Mode settings), program the Specified Senders (Key Operator Settings) along with the paper. See p.132 “Reception Setting”. See p.152 “Special Senders to Treat Differently”.
- ❑ The print area is determined by the optional expansion memory, resolution, and the vertical length of the originals.
- ❑ If paper longer than 600 mm is used, the paper may get wrinkled, it may not be sent, or a paper jam may occur.
- ❑ The machine can detect A4☐, A3☐(8¹/₂"×11"☐, 11"×13"☐) paper sizes. When you load any other size, specify the paper size. See p.158 “Programming Bypass Tray Paper Size”.

- ❑ When using tray 1 of the optional 1000-sheet finisher, paper is output to the tray even with non-standard sizes selected.
- ❑ If the specified paper size and the size of paper set in the bypass tray do not match, paper jams may occur, or the image may be truncated.
- ❑ If messages are printed on paper smaller than A4, the image may be truncated, or split across sheets.
- ❑ If you use this function, Image Rotation and 180-Degree Rotating Printing are not possible.

Where Incoming Message are Delivered - Output Tray

Specifying Tray for Lines

The optional extra G3 interface unit is required.

You can specify the document feeding tray for each port. For example, you can specify documents received through the G3 -1 port to be fed to the "Internal Tray 1" and documents received through the G3 -2 port to be fed to the "Internal Tray 2", facilitating separation of files.

Note

- To use this function, specify the port and destination using **[Specify Tray for Lines]**. See p.132 "Reception Setting".

Tray Shift

The optional finisher or shift sort tray unit is required.

When the optional finisher unit is selected for fax output, you can use the Tray Shift function whenever a fax or report is printed.

This is useful for separating faxes stacked in the finisher output tray. For example, if the previous incoming fax was output to the left, the next incoming fax will be output to the right and vice-versa.

Note

- You can turn this function on or off with the User Parameters. See p.147 "Changing the User Parameters" (switch 19, bit 0).

6. LAN-Fax Features

Sending Fax Documents from Computers

The optional printer/scanner unit is required to use this feature.

Using computers connected to the machine through parallel ports, IEEE 1394 (IP Over 1394) ports, LANs, or wireless LANs, you can fax documents, created using Windows applications, to other fax machines over a telephone line.

- To send a fax, simply select **[Print]** from the Windows application, then select LAN-Fax as the printer, and then specify a destination.
- In addition to sending faxes, LAN-Fax Driver allows this machine to be used for printing out documents prepared on a computer for proof checking.
- To use LAN-Fax Driver, connect this machine to a LAN and make the necessary network settings, and then install LAN-Fax Driver and related utilities on your computer.

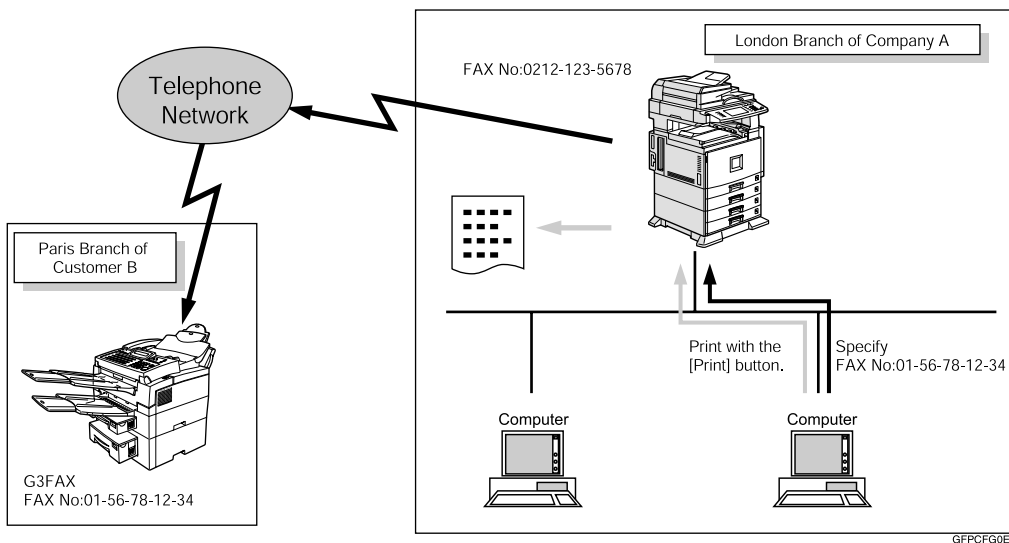

Important

- Errors occurring when the machine is used as a LAN-Fax will not be displayed on the computer. Check the help menus using a Web browser.

Installing the Software

You need to install LAN-Fax Driver on your computer before using the LAN-Fax functions. LAN-Fax Driver is on the CD-ROM included with the printer.

Address Book and LAN-Fax Cover Sheet Editor are installed with LAN-Fax Driver. Address Book helps you edit LAN-Fax transmission destinations. LAN-Fax Cover Sheet Editor helps you edit LAN-Fax cover sheets.

Note

- ❑ The following explanation assumes that you are familiar with general Windows procedures and practices. If you are not, see the documentation that comes with Windows for details.

Auto Run Program

With Windows 95/98/Me, Windows 2000/XP, and Windows NT4.0, the installers for various drivers and utilities launch automatically as Auto Run programs when you insert the CD-ROM.

If your operating system is Windows 2000/XP or Windows NT 4.0, installing a printer driver using Auto Run requires Administrator permissions. When you install LAN-Fax Driver using Auto Run, log on using an account that has Administrator permissions.

Note

- ❑ If the plug and play function starts, click **[Cancel]** in the **[New Hardware Found]**, **[Device Driver Wizard]**, or **[Found New Hardware Wizard]** dialog box, and then insert the CD-ROM. The **[New Hardware Found]** or **[Found New Hardware Wizard]** dialog box appears depending on the system version of Windows 95/98/Me, Windows 2000, or Windows XP.
- ❑ Auto Run might not work automatically with certain OS settings. If this is the case, double-click "Setup.exe", located on the CD-ROM root directory.
- ❑ If you want to cancel Auto Run, hold down the **[SHIFT]** key (when your system is Windows 2000/Windows XP, hold down the left **[SHIFT]** key) while inserting the CD-ROM. Keep the **[SHIFT]** key hold down until the computer stops reading the CD-ROM.
- ❑ Clicking **[Cancel]** during installation aborts the installation. If you cancel the installation, restart your computer and install the rest of the software or printer driver.

LAN-Fax Driver, Address Book, and LAN-Fax Cover Sheet Editor can be installed by Auto Run.

Installing Individual Applications

Use the following procedure to install LAN-Fax Driver, Address Book, and LAN-Fax Cover Sheet Editor at one time.

Before installing the above applications, install SmartNetMonitor for Client. See *Printer Reference 1*.

1 Quit all applications currently running.

2 Insert the CD-ROM included with this machine into the CD-ROM drive of your computer.

The installer launches automatically, and the language selection window appears.

Note

- Depending on your operating system settings, the installer may not launch automatically. If it does not, double-click "SETUP.EXE" in the CD-ROM root directory to launch the installer.

3 Select the interface language of the software, and then click [OK].

4 Click [LAN-Fax Driver].

The software license agreement window appears.

5 Read all of the terms and, if you agree, select [I accept the agreement], and then click [Next].

Note

- If you select [I don't accept the agreement], you cannot complete the installation.

6 Click the [LAN-Fax Driver] check box, and then click [Next].

7 Confirm that the [Printer Name:<LAN-Fax M3>] check box has been selected, and then click [Continue].

8 Click [Finish].

The installation completion dialog box appears.

9 Click [Finish].

10 Click [Exit].

Applications Stored on the CD-ROM

This section provides information about LAN-Fax Driver, Address Book, and LAN-Fax Cover Sheet Editor.

LAN-Fax Driver

This driver allows you to use LAN-Fax functions.

❖ Location of the File

The following folders are on the CD-ROM:

- LAN-Fax Driver for Windows 95/98/Me
 \DRIVERS\LAN-FAX\WIN9X_Me
- LAN-Fax Driver for Windows 2000/XP
 \DRIVERS\LAN-FAX\WIN2K_XP
- LAN-Fax Driver for Windows NT4.0
 \DRIVERS\LAN-FAX\NT4

❖ Operating Environment

- Computer
 PC/AT Compatible
- Operating Systems
 Microsoft Windows 95/98/Me
 Microsoft Windows 2000/XP
 Microsoft Windows NT4.0
- Display
 VGA 640×480 dots or more

Limitation

- All operations cannot be guaranteed depending on the system environment.
- When you use Windows NT, LAN-Fax Driver will not work in an RISC base processor (MIPS R series, Alpha AXP, PowerPC) environment.

Note

- Before beginning installation, exit all other applications.

Address Book

Address Book helps you edit LAN-Fax transmission destinations.

Operating Systems

Microsoft Windows 95/98/Me
Microsoft Windows 2000/XP
Microsoft Windows NT4.0

LAN-Fax Cover Sheet Editor

LAN-Fax Cover Sheet Editor helps you edit LAN-Fax cover sheets.

Operating Systems

Microsoft Windows 95/98/Me
Microsoft Windows 2000/XP
Microsoft Windows NT4.0

Setting LAN-Fax Properties

This section describes how to make settings such as paper size, resolution, and options.

- Paper size
- Orientation
- Tray
- Resolution
- Gray scale
- Printing images of True Type fonts

When this machine is connected to a network, selections for the option configuration are automatically performed.

For details, see Help.

Limitation

- If your operating system is Windows 2000/XP or Windows NT4.0, log on using an account that has Administrator permissions.

Note

- If the options on this machine are not configured as instructed, LAN-Fax functions may fail to work as intended.

1 On the [Start] menu, point to [Settings], and then click [Printers].

Note

- With Windows XP Professional, select [Printers and Faxes] on the [Start] menu.
- With Windows XP Home Edition, select [Control Panel] on the [Start] menu. Next select [Printers and Other Hardware], and then [Printers and Faxes].

- 2** Double-click [LAN-Fax M3], and then click [Properties] on the [File] menu.

 **Note**

- With Windows NT, click [Document Default] on the [File] menu.

- 3** Make settings for the option configuration.

When using Windows 95/98/Me

- 1** Click the [Paper] tab.
- 2** Click [Accessories...].

When using Windows 2000, Windows XP, or Windows NT

- 1** Click the [Advanced] tab.
- 2** Click [Printing Defaults...].
- 3** Click [Accessories...].

- 4** Confirm the settings for the option configuration.

When using a network

- 1** If the settings do not match the installed optional units, click [Reload from Device].

When not using a network

- 1** Select the check box besides the installed optional units.

- 5** Click [OK].

The settings for the option configuration are completed.

- 6** Click [OK].

Basic Transmission

This section describes how to send fax documents created using Windows applications.

To send a fax, simply select [Print] from the Windows application, then select [LAN-Fax] as the printer, and then specify a destination in the [LAN-Fax] dialog box.

Open the application document you want to send or create a new document, and then perform the following procedure.

For details, see Help.

 **Limitation**

- When using SmartNetMonitor for Client, you cannot send documents to this machine using more than one LAN-Fax at the same time.

- 1** On the [File] menu, click [Print].

- 2** Select [LAN-Fax M3] in [Printer Name].

- 3** Click [OK].

The LAN-Fax dialog box appears.

 **Note**

- The setting method may differ depending on the application you are using. In all cases, select [LAN-Fax M3] for the printer.

- 4** Specify the destination.

Use one of the following procedures to specify a destination. For details, see Help.

 **Note**

- You can select the appropriate line in the **[Line]** list.
- You can specify up to 500 destinations.
- The machine can hold up to 64 documents sent using LAN-Fax, as those to be transmitted.

Specifying a destination using a Destination list

① Enter a destination in the [Fax Number] box.

When using a Destination list:
Enter **[#]** and the registration number.

② Click [Next Number].

The entered destination is added and displayed in the **[List of Destinations]** box.

 **Note**

- If you do not want the entered destination to be added to the list, skip this step. Also when this step is skipped, the document will be sent to the number entered in the **[Fax Number]** box.
- ③ To specify more destinations, repeat steps ① and ②.**

Specifying a destination by directly entering a fax number

① Enter a fax number in the [Fax Number] box. **Note**

- To enter a pause, click **[Pause]**.

② Click [Next Number].

The entered destination is added and displayed in the **[List of Destinations]** box.

 **Note**

- If you do not want the entered destination to be added to the list, skip this step. Also when this step is skipped, the document will be sent to the number entered in the **[Fax Number]** box.
- ③ To specify more destinations, repeat steps ① and ②.**

Specifying a destination using Address Book

In order to use this method, you need to register destinations in the address list using Address Book. See p.98 "Address Book".

① Select a CSV file containing the desired address list, from the drop-down menu. **Note**

- Up to three files used most lately appear in the drop-down menu. To use an address list that did not appear, click **[Browse...]**, and then select the file.
- ② In the [Name] list select [Contact], [Company], or [Group], and then select [ALL] or an initial letter.**
- The destinations matching the selected parameters appear.

- ③ Click the destination to highlight it, and then click **[Set as Destination]**.

The entered destination is added and displayed in the **[List of Destinations]** box.

- ④ To specify more destinations, repeat steps ② and ③.

5 Specify options.

Reference

See p.101 "Attaching a cover sheet".

See p.103 "Specifying Two-Sided Printing".

See p.101 "Previewing fax images".

See p.103 "Printing or Saving as Files".

See p.101 "You can specify the following options:".

If you do not want to specify options, proceed to step 6.

6 Click **[Send]**.

Note

- When you click **[Print&Send]**, a fax will be transmitted to the destination and a copy of the document you send will be printed from your machine.

Attaching a cover sheet

Selecting the **[Attach a Cover Sheet]** check box causes a cover sheet to be attached to the top of the fax document.

The cover sheet includes the following items:

- Company name as destination info.
- Department name as destination info.
- Person name as destination info.

- Title of address as destination info.
- Company name as sender info.
- Department name as sender info.
- Person name as sender info.
- Telephone number as sender info.
- Fax number as sender info.
- Date
- Message

Note

- To edit the cover sheet, click **[Cover Sheet...]**. See p.105 "Editing Fax Cover Sheets".

Previewing fax images

Selecting the **[Preview]** check box allows you to check how the fax document will be output at the destination.

- 1 Select the **[Preview]** check box, and then click **[Print]** or **[Send]**.

The **[Preview]** window appears.

- 2 Check the image, and then click **[OK]**.

Note

- To cancel printing or sending, click **[Cancel]**.

Images on the Preview window are not exactly the same as images to be output.

Specifying options

You can specify the following options:

For details, see Help.

- Sending at a Specific Time
- User Code
- User ID
- Print Fax Header
- Document Server

1 Click [Option...].

2 Specify options you want to use.

❖ **To send the fax document at a specific time:**

Select the [Sending at a Specific Time] check box, and then specify a transmission time.

❖ **To send with a user code:**

Enter a user code into the [User Code] field.

❖ **To distinguish fax documents for each user:**

Enter a user ID into the [User ID] field. Use this option when checking the job history using SmartNetMonitor.

❖ **To have the header printed on the fax document:**

Select the [Print Fax Header] check box.

❖ **To store the fax document on the Document Server:**

Select the [Send to Document Server] check box, and then enter a user name, file name, and password.

 **Note**

The user code you specified for this machine must be the same as the one entered in this machine. See the *General Settings Guide*.

If [Hard Disk Unit] has not been selected in the [Accessories] window, you cannot perform selection for "Document Server". See p.98 "Setting LAN-Fax Properties".

3 Click [OK].

 **Transmission result notification**

After you have sent faxes, this function informs you whether the fax was successfully transmitted to its destination or not.

When you store documents in the Document Server or use this machine just as a printer, this function also informs you whether data was successfully transmitted to this machine or not.

 **Note**

You cannot receive notification when using SmartNetMonitor for Client version 5.0 or earlier.

Transmission results are informed only when connected with a network using SmartNetMonitor for Client.

 **Managing transmission using LAN-Fax Driver**

From "SmartNetMonitor for Admin", "SmartNetMonitor for Client", or a Web browser, you can manage transmissions using LAN-Fax Driver. You can view the following information on transmitted files using LAN-Fax Driver.

- User ID
- Status
- Number of pages
- Start time
- File No.

 **Reference**

For details, see Help.

Printing or Saving as Files

You can print documents created using Windows applications.

You can also save documents in TIF format.

Open the application document you want to print or create a new document, and then perform the following procedure.

For details, see Help.

Note

- You can select whether to cause the machine to automatically restart printing when problems such as paper running-out or paper jams are resolved. The machine may not allow LAN-Fax Driver to send documents until it finishes re-printing. See p.147 "Changing the User Parameters" (switch 20, bit 1).
- You can select the time delay after problems are resolved until the machine restarts printing. See p.147 "Changing the User Parameters" (switch 20, bit 2/3/4/5).

1 On the **[File]** menu, click **[Print...]**.

2 Select **[LAN-Fax M3]** in **[Printer Name]**, and then click **[OK]**.

The **[LAN-Fax]** dialog box appears.

Note

- The setting method may differ depending on the application you are using. In all cases, select **[LAN-Fax M3]** for the printer.

Printing

- 1** Click **[Print]**.

Specifying Two-Sided Printing

- 1** Selecting the **[Duplex printing]** check box.
- 2** Click **[Print]**.

Saving as Files

You can save the fax document in TIF format.

- 1** Select the **[Save as file]** check box.
- 2** Click **[Save to...]**.
- 3** Select a folder on the folder tree.
- 4** Select a file naming method.

Note

- To manually enter a file name, select the **[Specify file name when saving]** check box. To have the program itself name the file, select the **[Automatically create a new file]** check box.

- 5** Click **[OK]**.
- 6** Click **[Save]**.

If you have selected **[Automatically create a new file]**, the image file is assigned a name and saved under the specified folder. The file name will be RicHH-MMSS.tif (HH: hours, MM: minutes, SS: seconds).

- 7** Enter a file name.

Note

- You can also change the folder in this step.

- 8** Click **[Save]**.

The image file is saved in the specified folder.

Address Book

You can program and edit destinations in the address list using the Address Book.

For details, see Help.

- 1** On the [Start] menu, point to [Programs], [LAN-Fax Utilities], and then click [Address Book].
- 2** Click [New/Browse], and then select the CSV file containing the address list to be edited.
- 3** Edit an existing destination or program a new one.

 **Note**

- You can use files created in CSV format, as Address Book data. For this purpose, create CSV files that conform to a certain format. For more information, see Help.
- You can register the Address Book data of this machine in the LAN-Fax's Address Book.

Programming new destinations

- 1** Enter the destination.

 **Note**

- For [Line], select the appropriate line type; G3, G3-2, or G3-3. Do not select G4, which is unavailable on this machine.

- 2** Click [Add].

Editing programmed destinations

- 1** Select the destination you want to edit in the list.

The company name should appear in gray.

- 2** Edit the data.
- 3** Click [Update].

Deleting programmed destinations

- 1** Select the destination you want to edit in the list.

The company name should appear in gray.

- 2** Click [Delete].
- 3** Click [Yes].

- 4** Click [Close].

- 5** If you made changes to a destination, a confirmation message appears. To save the changes, click [Yes].

If you do not want to save the changes and want to quit editing, click [No].

To return to the editing display, click [Cancel].

 **Note**

- The confirmation dialog box does not appear when you have not made any changes after starting Address Book.

Using the machine's Address Book data as the LAN-Fax's Address Book data

You can retrieve the Address Book data of this machine using SmartNetMonitor for Admin and edit it to register in the LAN-Fax's Address Book.

Reference

For more information, see Help on SmartNetMonitor for Admin.

Managing the facsimile functions using SmartNetMonitor for Admin

Using SmartNetMonitor for Admin, you can check information about the machine's facsimile functions and save the information on the computer.

SmartNetMonitor for Admin provides the following management functions:

Using **[Address Management Tool]**, you can check the information about destinations registered on the machine and change the fax numbers and names of these destinations. You can also register a new destination.

Using **[Address Management Tool]**, you can retrieve destinations registered on the machine and save them on the computer as CSV files. You can then export the saved CSV files to the Address Book of LAN-Fax Driver using the Address Book application.

Note

- For the method of installing SmartNetMonitor for Admin, see the *Printer Reference 1*.

- For detailed operations, see the *Network Guide* and Help on SmartNetMonitor for Admin.

Editing Fax Cover Sheets

LAN-Fax Cover sheet Editor allows you to edit the format for fax cover sheets. It is necessary to create a cover sheet file before attaching a cover sheet to fax messages using LAN-Fax Driver.

Creating a cover sheet

Use the following procedure to create a fax cover sheet.

You can edit the items below using LAN-Fax Cover Sheet Editor.

- Company name as destination info.
- Department name as destination info.
- Person name as destination info.
- Title of address as destination info.
- Company name as sender info.
- Department name as sender info.
- Person name as sender info.
- Telephone number as sender info.
- Fax number as sender info.
- Date
- Message

Note

- Cover sheet data is stored in its own format (using "fcp" as its extension)

1 On the **[Start]** menu, point to **[Programs]**, **[LAN-Fax Utilities]**, and then click **[Cover Sheet Editor]**.

The dialog box of LAN-Fax Cover Sheet Editor appears.

2 Edit the cover sheet. **Note**

- For details about operations, see Help.

3 Click **[Save As]** on the **[File]** menu.**4** Select a folder, and then enter a file name.**5** Click **[Save]**.

Attaching a created cover sheet

Use the following procedure to attach a created cover sheet file to a fax message.

1 On the **[File]** menu, click **[Print...]**.**2** Select "LAN-Fax M3" in "Printer Name", and then click **[OK]**.

The **[LAN-Fax]** dialog box appears.

3 Click **[Cover Sheet...]**.

The **[Cover Sheet]** dialog box appears.

4 Select a cover sheet file from the drop-down list or after clicking **[Browse...]** in **[Select Cover Sheet]**. **Note**

- The selection made in **[Select Cover Sheet]** is not canceled unless you select another file. If you want to change only destination information, skip this step and proceed to step **5**.

5 Enter the destination information. **Note**

- You can select **[(Import from) Address Book]**, **[Whom It May Concern]**, **[Edit Names]**, or **[None]**. Selecting **[Edit Names]** allows you to enter company, department, and person names.

6 To print the date, select the **[With a Date]** check box.**7** Enter the sender information. **Note**

- You can enter company, department, and person names, and telephone and fax numbers.
- To add a message, select the **[With a Message]** check box, and then enter a message.

8 Click **[OK]**.**9** Specify a destination.**10** Select the **[Attach a Cover Sheet]** check box.**11** Click **[Send]**.

LAN-Fax Operation Messages

Message	Causes and Solutions
Cannot access the printer. Click [re-try] to send the data again.	Check the network connection. Check that the power is turned on.
The number of destination entries exceeds the limit. Up to 500 entries can be entered.	The number of destinations specified exceeds the maximum possible. The maximum number of destinations that can be specified at one time is 500.
“LAN-Fax” has already been launched. Cannot launch it again.	The [LAN-Fax] dialog box is already open. Quit LAN-Fax once, and then start it up again.
Failed to allocate memory.	Available memory on the computer is insufficient. Quit applications currently not in use.

LAN-Fax Error Report

This report is printed when options are not properly selected or a communication error with a computer occurs.

Note

- You can select whether or not a LAN-Fax Error Report is printed. See p.147 “Changing the User Parameters” (switch 20, bit 0).

Error messages

The following error messages appear on the upper or lower section of the display.

	Display locations	Error messages
1	Upper section	THIS FILE WAS NOT STORED DUE TO LAN-FAX ERROR.
	Lower section	EXCEEDED MAXIMUM FILE CAPACITY. EXCEEDED MAXIMUM NUMBER OF PAGES PER FILE.
2	Upper section	TRANSMISSION REQUEST WAS CANCELED.
	Lower section	YOU CANNOT SPECIFY DESTINATION NOW.
3	Upper section	TRANSMISSION REQUEST WAS CANCELED.
	Lower section	FAX NUMBER IS NOT CORRECT. FAX NUMBER OR LINE IS NOT CORRECT.
4	Upper section	ERROR DURING COMMUNICATION WITH PC.
	Lower section	-
5	Upper section	TRANSMISSION REQUEST WAS NOT ACCEPTED.
	Lower section	YOU ARE NOT AUTHORIZED TO ACCESS.

Viewing Fax Information Using a Web Browser

The optional printer/scanner unit or network board is required. When the network board is used, the optional SDRAM 128 MB is also required.

You can view received fax messages and their lists or print these messages using a Web browser on a network computer.

Note

- You need to select "Store" as the "Reception File Setting" in the Facsimile Features menu. See p.172 "Storing or Printing Received Documents".

Viewing and/or Printing Received Fax Messages Using a Web Browser

Use the following procedure to view and/or print received fax messages using a Web browser.

Viewing received fax messages using a Web browser

- 1** Start a Web browser.
- 2** Enter the machine's IP address in the [Address] field.
- 3** Click [Fax Received File].

With a user code programmed

- 1** If you have programmed a user code, enter the code, and then press [OK].

A list of the received fax messages appears.

Note

- If the programmed user code has been deleted using the Address Book Management function under System Settings, a message indicating incorrect user code entry appears. If this is the case, reprogram a user code. See p.173 "Setting a User Code for Viewing Received and Stored Documents".

- 4** Click the Property icon of the desired fax message.

Information such as reception dates, senders, line types, number of pages, and file numbers appear in addition to preview images.

Note

- To view a thumbnail list of the fax messages, click [Thumbnails].

- 5** View the content of the fax message.

Note

- To enlarge the preview image, click [Enlarge Image]. Enlargement cannot be performed without Acrobat Reader installed. For more information, see Help on the Web browser.

6 To download the received fax message, click **[PDF]** or **[Multi-page TIFF]**.

Clicking **[PDF]** causes Acrobat Reader to be started and the message to be displayed.

Clicking **[Multi-page TIFF]** causes a downloading confirmation window to appear.

 **Note**

- The method for downloading differs depending on the selected format. For more information, see Help on the Web browser.

Printing fax information using a Web browser

1 Start a Web browser.

2 Enter the machine's IP address in the **[Address]** field.

3 Click **[Fax Received File]**.

The list of received fax messages appears.

4 Click and check the check box beside the fax message to be printed.

 **Note**

- To view a thumbnail list of the fax messages, click **[Thumbnails]**.

5 Click **[Print]**.

6 Click **[Start Print]**.

 **Note**

- To cancel printing, press **[Cancel]** before clicking **[Start Print]**.

- You can change the printing order of selected multiple messages. You can also have messages printed on both sides of paper. For more information, see Help on the Web browser.

7 Click **[OK]**.

The display returns to that of step **4**.

Deleting fax information using a Web browser

1 Start a Web browser.

2 Enter the machine's IP address in the **[Address]** field.

3 Click **[Fax Received File]**.

The list of received fax messages appears.

4 Click and check the check box beside the fax message to be deleted.

 **Note**

- To view a thumbnail list of the fax messages, click **[Thumbnails]**.

5 Click **[Delete]**.

6 Click **[Delete File]**.

 **Note**

- To cancel deletion, press **[Cancel]** before clicking **[Delete File]**.
- After selecting multiple messages, you can also cancel deletion of some of the selected messages. For more information, see Help on the Web browser.

7 Click **[OK]**.

The display returns to that of step **4**.

Viewing Received Messages on a Computer

ScanRouter V2 Professional (sold separately) is also required as a delivery server. DesktopBinder V2 Professional Lite or DesktopBinder V2 Professional software (both sold separately) must be installed on your computer.

Note

- This manual uses the name DesktopBinder V2 Professional/Lite to refer to both DesktopBinder V2 Professional Lite and DesktopBinder V2 Professional.

Delivering Received Messages

Messages received by the machine can be viewed on or downloaded to a computer with the networked delivery server, ScanRouter V2 Professional. This is a useful function, enabling you to view and store messages on your computer without printing them.

Using the delivery server, you can eliminate the task of retrieving and delivering messages.

◆ Functions

Delivery server provides the following functions:

- Use the delivery server to associate incoming messages (Confidential ID, SUB Code, Own Name, and Own Fax Number) with receivers, so messages are delivered to the intended receivers.

- You can select the delivery method for incoming messages: "Save in the delivery server inbox," "Send as an e-mail attachment," or "Save in the designated PC folder." Incoming messages with no Confidential ID, SUB code, Own Name, or Own Fax Number are saved in the delivery server inbox.
- You can check or download received messages stored in the delivery server inbox using DesktopBinder V2 Professional Lite or DesktopBinder V2 Professional.

Limitation

- Confidential messages are also forwarded to the delivery server.

Note

- To view or download messages stored in the delivery server inbox, you need to install the separately sold DesktopBinder V2 Professional Lite or DesktopBinder V2 Professional on your computer.
- To send received messages to your computer as e-mail attachments, you need to have a ScanRouter V2 Professional-compatible e-mail program on your computer.

- ❑ To create a network using the delivery server, settings must be specified in the User Tools of the machine. Settings must also be specified on the delivery server. See “Configuring the Network”, *General Settings Guide*.
- ❑ See ScanRouter V2 Professional Help or instructions for more information on the delivery server (ScanRouter V2 Professional).
- ❑ For information about DesktopBinder V2 Professional/Lite, see DesktopBinder V2 Professional/Lite Help or instructions.

7. Simplifying the Operation

Programs

If you regularly send messages to a particular destination or transmit using the same functions, you can save repetitive keypad operations by registering this information in a Keystroke Program.

Registering and Changing Keystroke Programs

Keystroke Programs can be recalled by just pressing a Quick Dial key. The following procedure can be used to program a new Keystroke Program or overwrite an old one.

You can register the following items in Keystroke Programs:

- Memory Transmission, Immediate Transmission, destinations (up to 500 numbers), resolution, original type, G3 communication mode, Stamp, Send Later, Default ID, Auto Image Density, Manual Image Density, Scan Area, Auto Document, Book Fax, Polling Transmission, Polling Reception, Transfer Request, two-sided transmission, optional functions
- Program name (up to 20 characters)

Note

- The maximum number of programs you can register is 100 (200 with the optional fax function upgrade unit).
- Use the same procedure to register and change programs. Follow the procedure for the items you want to change.

- The method of registering or changing programs for the copy function is different from that of the fax function.
- You cannot register any destination or Polling Transmission using program No. 1.

1 Prepare for registering the program.

Note

- The procedure for programming differs depending on the items you want to register.
- Press the **[Clear Modes]** key to cancel programming.

Example of registering a program using Send Later with the fax number "0123456789"

- 1** Press **[0], [1], [2], [3], [4], [5], [6], [7], [8], [9]** using the number keys.
- 2** Press **[Transmission Mode]**.
- 3** Select **[Send Later]**.
- 4** Enter the time to send, and then press **[OK]**.

Note

- If "Send Later" has already been specified, that time is shown. Press the **[Clear Modes]** key to change "Send Later".

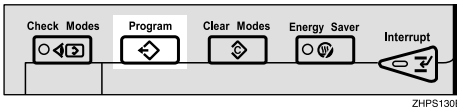
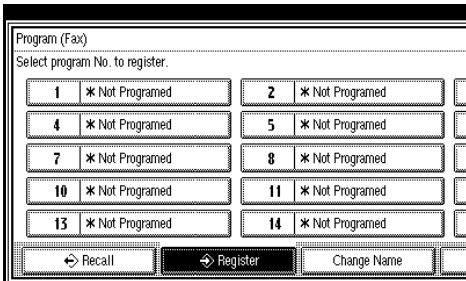
2 Press the **[Program]** key.**3** Press **[Register]**.**4** Select a program number in which “*Not Programed” is shown.**Note**

- If you make a mistake, press **[Cancel]** and select a program number again.
- When you change a Keystroke Program, press **[Store]** after pressing the program number you want to change. If you make a mistake, press **[Do not Store]** and return to step **4**.

5 Enter the program name, and then press **[OK]**.

The standby display appears.

Note

- If you make a mistake, press **[Backspace]** or **[Delete All]**, and then try again.
- You should register the program name.
- To cancel a registered program, press **[Cancel]**. The display returns to that of step **4**.

Reference

"Entering Text", *General Settings Guide*

Registering a priority function using a program

You can select whether or not the function registered in program No. 1 will be set after the power is turned on or the **[Clear Modes]** key is pressed.

After registering a function in program No. 1, select **[Program No. 1]** for **[Change Initial Mode]** on the Facsimile Features menu. See p.130 "General Settings/Adjustment".

Note

- For this purpose, program No.1 does not allow you to program destinations, Polling Transmission, User Transmission, Store File, Scan Area, Resolution, Image Density and Send Stored-file functions.

Using a program**Note**

- Using the program causes the previous settings to be cleared.

Example of executing a program using Send Later with the fax number "0123456789"

1 Make sure that the machine is in facsimile mode and the standby display is shown.**Note**

- If the standby display is not shown, press the **[Facsimile]** key.

2 Place the original.**Note**

- If you have no registered destinations or scan settings as programs, enter the fax number of the destination and select the scan settings you require.

- 3 Press the **[Program]** key.

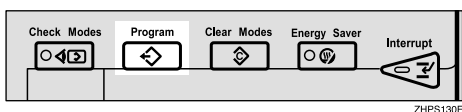

- 4 Select the program number you registered.

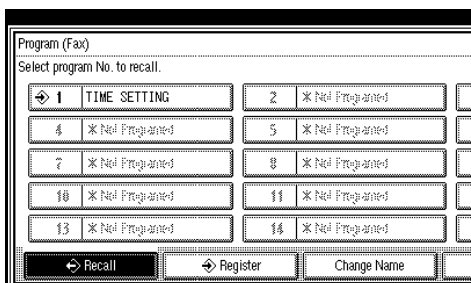

The initial display appears.

Then, the registered fax number and time are shown. Transmission Mode is selected.

- 5 Press the **[Start]** key.

The fax number and specified time are shown on the display, and the machine starts to scan the original.

Changing a program name

- 1 Make sure that the machine is in facsimile mode and the standby display is shown.

Note

- If the standby display is not shown, press the **[Facsimile]** key.

- 2 Press the **[Program]** key.

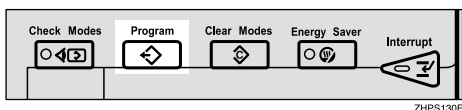

- 3 Press **[Change Name]**.

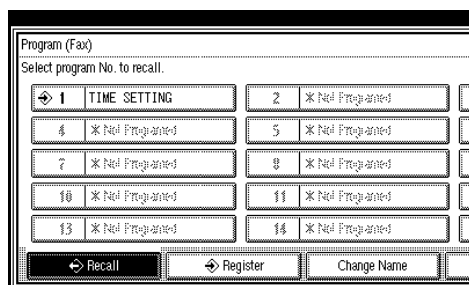

- 4 Select the program number of the name you want to change.

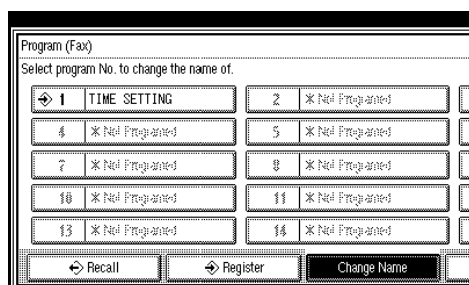

- 5 Enter a new program name, and then press **[OK]**.

Note

- Press **[Cancel]** to cancel the change, and proceed to step 6.

- 6 Press **[Exit]**.

The initial display appears.

Deleting a Program

1 Make sure that the machine is in facsimile mode and the standby display is shown.

Note

□ If the standby display is not shown, press the **[Facsimile]** key.

2 Press the **[Program]** key.

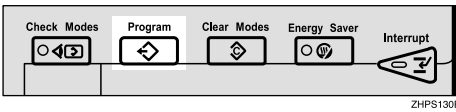

3 Press **[Delete]**, and then select the program number you want to delete.

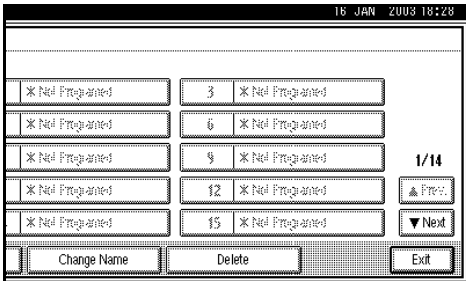

The contents of the program are shown on the display.

4 Select the program number you want to delete.

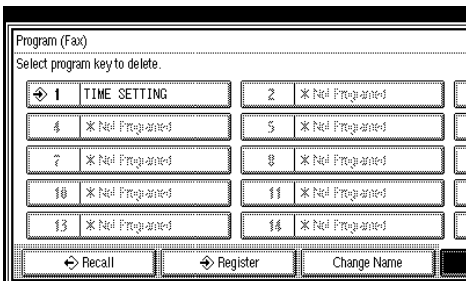

The contents of the program are shown on the display.

5 Press **[Yes]**.

Note

□ Press **[No]** not to delete the program. The display returns to that of step **3**.

6 Press **[Exit]**.

The initial display appears.

Using the Document Server

Use this function to store documents in the Document Server on this machine.

The Document Server can store documents from various applications.

The documents that are stored using the facsimile function are available to transmit by facsimile.

Storing in the Document Server enables the following:

- Once stored, a document can be sent out as many times as you want, just by selecting it.
- Storing a document does not use facsimile memory.

You can send and print multiple stored documents as a single document, and also send them with scanned originals at the same time. Follow the instructions under **[Select Stored File]** in **[Sub TX Mode]** when sending or printing stored documents. See p.61 "Sending a Stored File".

Reference

"What You Can Do with This Machine", *General Settings Guide*

Important

- Data stored in the machine might be lost if some kind of failure occurs. The supplier shall not be responsible for any damage that might result from the loss of data.

Note

- Stored documents are not deleted even when there is a power failure, or the main power switch is turned off.

- You can specify whether or not the machine automatically deletes documents from the Document Server after a certain number of days. The delete function is pre-configured with the software and automatically deletes any stored document that is more than three days (72 hours) old. You can change the setting with "Key Operator Tools — Auto Delete File". See "Key Operator Tools — Auto Delete File", *General Settings Guide*.
- You can store approximately 9,000 pages (ITU-T No.4 chart) in the Document Server, using the fax, copy, facsimile, printer, and scanner functions.
- The fax feature has a memory capacity of approximately 3,000 documents.
- You can store up to 1,000 pages per document.
- You cannot check received and stored documents through the Document Server. See p.30 "Printing Received and Stored Documents".

Storing a Document

You can store and send a document at the same time. You can also just store a document.

❖ File names

Scanned documents are automatically assigned names like "FAX0001" or "FAX0002". See p.119 "Setting a file name".

❖ User Names

You can set this function if necessary to know who and what departments stored documents in the machine. See p.119 "Programming a user name".

❖ Password

You can set this function so as not to send to unspecified people. See p.119 "Setting a password".

Note

- You can change file names and user names. See p.120 "File Manage".

1 Make sure that the machine is in facsimile mode and the standby display is shown.

If the standby display is not shown, press the **[Facsimile]** key.

2 Place the original, and then select the scan settings you require.

3 Press **[Store File]**.

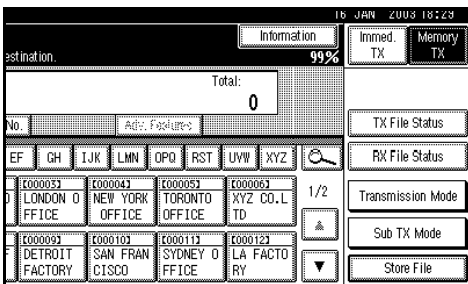

4 Select **[Store & Transmit]** or **[Store only]**.

Select **[Store & Transmit]** to send documents after they are stored.

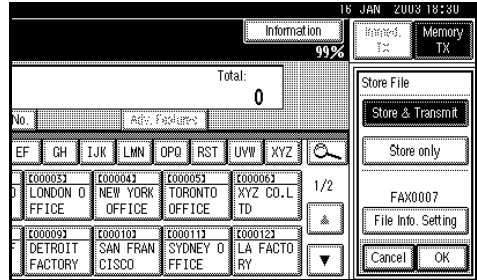

Select **[Store only]** to store documents.

When **[Store only]** is selected, "*****" is shown.

5 Press **[File Info. Setting]**, and then set the user name, file name, and password as necessary.

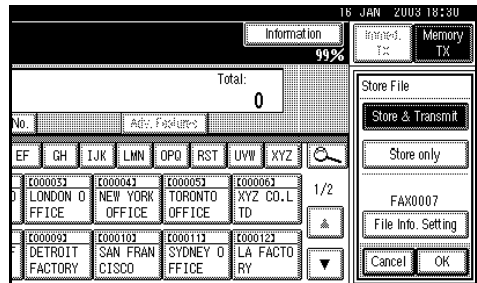

Note

- If you are not setting a user name, file name, or password, proceed to step 6.
- You cannot change multiple documents at once.

Programming a user name

Note

- ❑ Set a user name from those programmed in the user code. See the *General Settings Guide*.

1 Press [User Name].

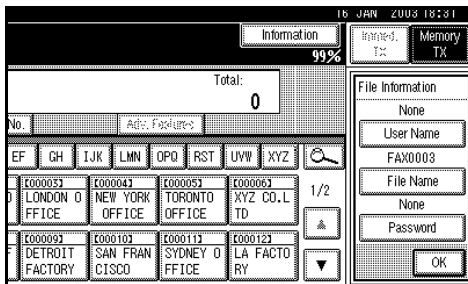

2 Press the user name to be programmed, and then press [OK].

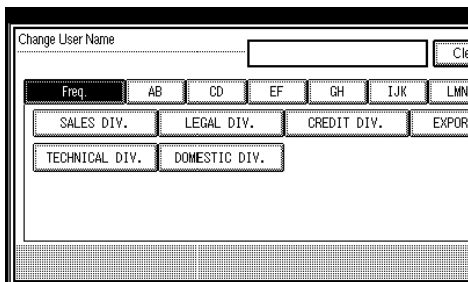

Note

- ❑ Press the title key to switch between titles.
- ❑ To set a non-programmed user name, press **[Non-programmed Name]**, and then enter the name. User names entered by pressing **[Non-programmed Name]** are not programmed into the user code.

3 Press [OK].

Setting a file name

1 Press [File Name].

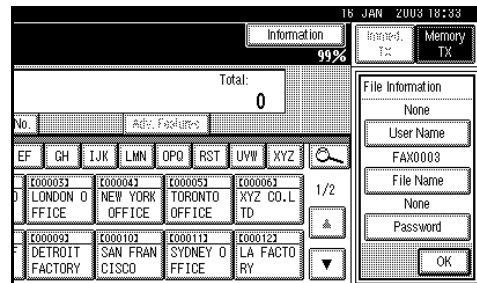

2 Enter the file name, and then press [OK].



Reference

“Entering Text”, *General Settings Guide*

3 Press [OK].

Setting a password

1 Press [Password].

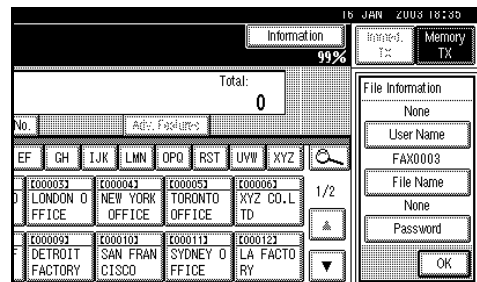

2 Enter a password using the number keys, and then press [OK].

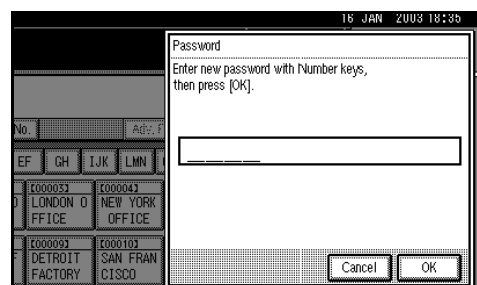

Note

- ❑ If you make a mistake, press **[Clear]** or the **[Clear/Stop]** key before pressing **[OK]**, and then reenter your password.

3 Press **[OK]**.

6 Press **[OK]**.

7 If you have selected **[Store & Transmit]**, specify the receiver.

Note

- ❑ If you have selected **[Store only]**, proceed to step **8**.

8 Press the **[Start]** key.

File Manage

You can change the file name, user name, and password of stored documents.

To change a stored document, delete the document you no longer need, and then reprogram the new document. See p.122 "Delete File".

Note

- ❑ You can program one of the Quick Operation keys with operations for this function. Using the key allows you to omit steps **1** and **2**.

1 Press **[Sub TX Mode]**.

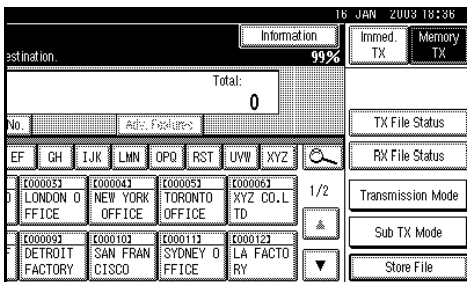

2 Select **[Select Stored File]**.

3 Select **[Manage/Delete File]**, and then press the document to be changed.

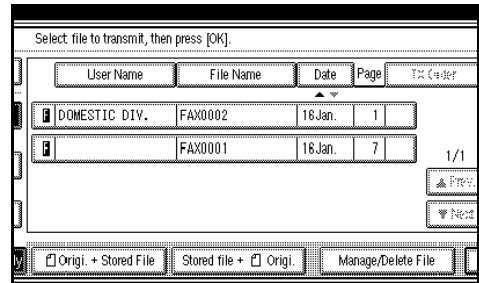

Note

- ❑ You can specify multiple documents at once.

4 If you select a document for which a password is set, enter the password, and then press **[OK]**. When a selected file does not have a password, proceed to step **5**.

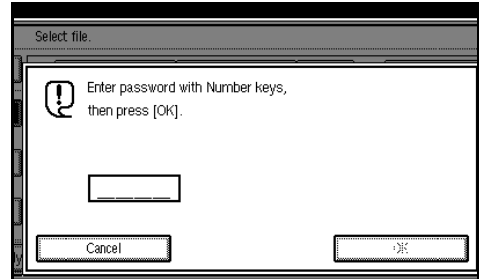

5 Change the desired information of the stored document.

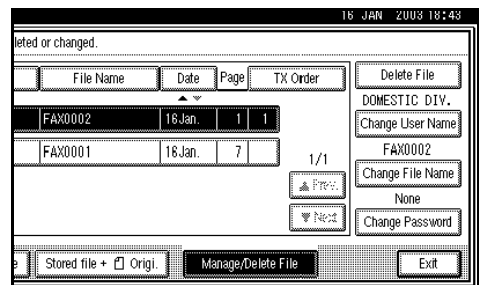

Changing a user name

- ❶ Press [**Change User Name**].
- ❷ Press [**Clear**].

The user name is deleted.

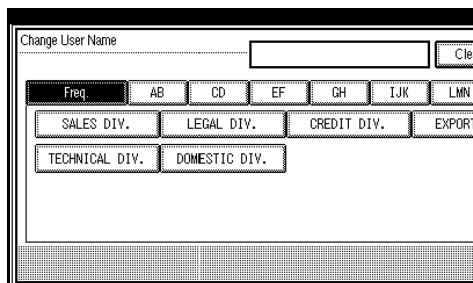

- ❸ Enter the new user name, and then press [**OK**].

Note

- Press the title keys to switch between titles.
- To set a non-programmed user name, press [**Non-programmed Name**], and then enter the name.
- User names entered by pressing [**Non-programmed Name**] are not programmed into the user code.

Reference

“Entering Text”, *General Settings Guide*

Changing the file name

- ❶ Press [**Change File Name**].
- ❷ Press [**Backspace**] or [**Delete All**], and then reenter the file name.

Reference

“Entering Text” *General Settings Guide*

- ❸ Press [**OK**].

Changing the password

- ❶ Press [**Change Password**].
- ❷ Enter a new password using the number keys, and then press [**OK**].

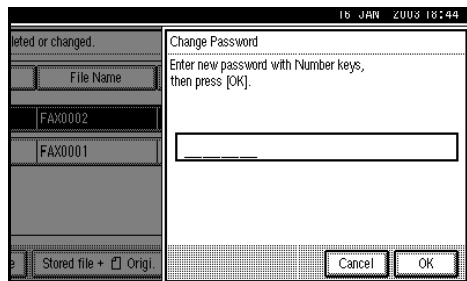

- ❸ Press [**OK**].

- ❹ Press [**Exit**].

- ❺ Press [**OK**].

The standby display appears.

Delete File

Use this function to delete stored documents.

 **Note**

- ❑ You can program one of the Quick Operation keys with operations for this function. Using the key allows you to omit steps **1** and **2**.

1 Press [Sub TX Mode].

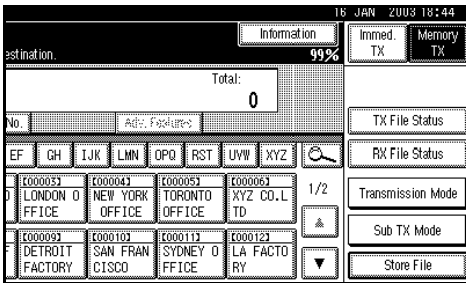

2 Select [Select Stored File].

3 Select [Manage/Delete File].

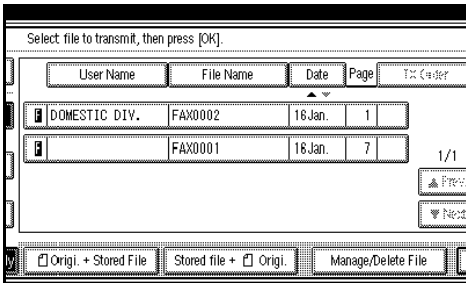

4 Select the document you want to delete.

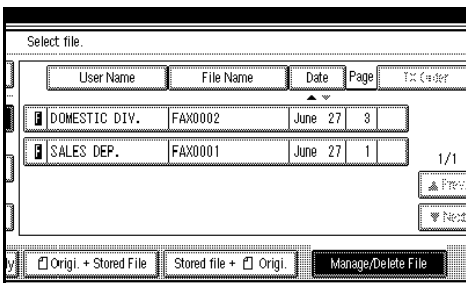

 **Note**

- ❑ You can also delete multiple documents at once.

With a programmed password

1 Enter a password using the number keys, and then press [OK].

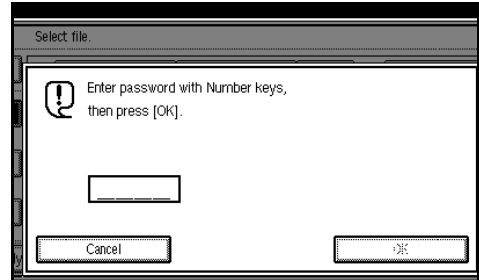

5 Press [Delete File].

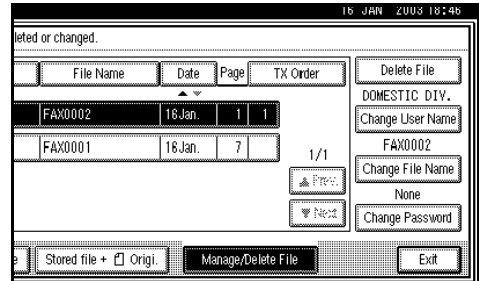

6 Press [Delete].

 **Note**

- ❑ If you do not want to delete the document, press [Do not Delete].

7 Press [Exit].

8 Press [OK].

The standby display appears.

Managing Documents Saved in the Document Server from a Computer

Using DesktopBinder

Fax documents saved in the Document Server can be viewed and controlled from a network computer with DesktopBinder V2 Lite or DesktopBinder V2 Professional installed.

The following operations are available using the computer:

- Displaying documents (Easy Viewer)
- Displaying document properties (Properties)
- Deleting documents (Delete)
- Copying documents to a computer (Copy)
- Printing documents (Print from Document Server)
- Sending documents by fax (Fax from Document Server)
- Exporting documents as files (Export Document)
- Automatically receiving documents sent to the delivery server.

For more information, see DesktopBinder V2 operating instructions and Help.

Note

- Settings made in System Settings enable you to send documents to the delivery server. See “Setting up the Machine on a Network”, *Network Guide*.

Using a Web browser

Fax documents saved in the Document Server can be viewed using a Web browser on a network computer. These fax documents can also be downloaded to the computer's hard disk. See p.109 “Viewing Fax Information Using a Web Browser”.

8. Facsimile Features

Function List

The User Tools allow you to register your identification, store frequently used numbers and settings, and customize default settings to meet your needs.

The User Tools are grouped by functions so that you can quickly and easily find the desired User Tool.

❖ General Settings /Adjustment

Description	Reference
<p>Default Transmission Mode and scan settings. When the power is turned on, settings specified here are selected:</p> <ul style="list-style-type: none">• Memory/Immediate Transmission Switch• Text Size Priority• Original Type Priority• Auto Image Density• Adjust Scan Density• Select Title• Change Initial Mode• Adjust Sound Volume• Program Fax Information• Scan End Reset• Transmission Stamp Priority• Line Priority Setting• Program Economy Time• On Hook Mode Release Time• Quick Operation Key	p.130 "General Settings/Adjustment"

◆ Reception Setting

Description	Reference
<p>Allows you to switch the following reception functions on or off:</p> <ul style="list-style-type: none"> • Switch Reception Mode • Authorized Reception See ⇒ p.156. • Forwarding See ⇒ p.156. • Reception File Print Quantity See ⇒ p.156. • Two-Sided Print See ⇒ p.85. • Reception Reverse Printing See ⇒ p.88. • Paper Tray See ⇒ p.157. • Specify Tray for Lines See ⇒ p.93. • Checkered Mark See ⇒ p.84. • Center Mark See ⇒ p.84. • Print Reception Time See ⇒ p.85. 	<p>p.132 "Reception Setting"</p>

◆ Key Operator Tools

Description	Reference
<ul style="list-style-type: none"> • Program/Change/Delete Standard Message • Store/Change/Delete Auto Document • Program/Change/Delete Scan Size • Print Journal • Transmission Page Count • Forwarding • Memory Lock Reception • ECM • Parameter Setting • Program Special Sender • Box Setting • Transfer Report • Program Confidential ID • Program Polling ID • Program Memory Lock ID • Select Dial/Push Phone • Reception File Setting 	p.135 "Key Operator Setting"

Displays

- Each menu appears in each tab.
- You can switch the display by pressing [**▲ Prev.**] or [**▼ Next**].
- The selected item is highlighted.
- When you have made all required settings, press [**OK**]. If [**OK**] is not pressed, the new settings might be canceled.
- Press [**Cancel**] to cancel the new settings. The previous display appears.

💡 Key Operator Code

When Key Operator Code is programmed and turned on, users have to enter a programmed Key Operator Code (eight digits maximum) to operate the User Tools. This prevents unauthorized people from changing settings.

📌 Note

- ❑ You can turn the Key Operator Code on or off in “System Settings”.
 - ❑ When you set the Key Operator Code to active, enter a code (eight digits maximum) using the number keys and select **[Partial]** or **[All Initial Settings]** to limit access.
 - When **[Partial]** is selected:
Only Key Operator Tools are protected with a Key Operator Code.
 - When **[All Initial Settings]** is selected:
Key Operator Tools and User Tools are protected with a Key Operator Code.
- ① Press the **[User Tools/Counter]** key.
 - ② Press **[Facsimile Features]**.
If you have selected **[All Initial Settings]**, proceed to step ④.
 - ③ Select **[Key Operator Tools]**.
 - ④ Enter a Key Operator Code (eight digits maximum) using the number keys.

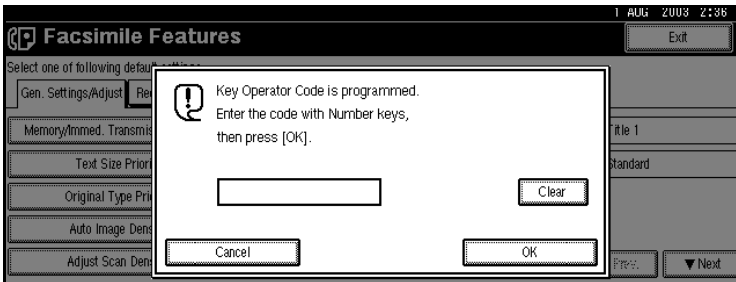

- ⑤ Press **[OK]**.

📌 Note

- ❑ If you enter a Key Operator Code not registered, the display will return to that of step ④.

Accessing User Tools (Facsimile Features)

Customize the facsimile settings according to the operations to be frequently performed.

Note

- ❑ The machine allows you to change the facsimile defaults in a mode that is not the facsimile mode. After changing the defaults, select facsimile mode again. This section describes the facsimile defaults that the machine allows you to customize.
- ❑ Customized facsimile defaults are kept until the defaults are changed again. The new settings are not cancelled by turning off the main power switch or the Operation switch or pressing the **[Clear Modes]** key.

Reference

For the items that can be changed using System Settings, see "User Tools (System Settings)", *General Settings Guide*.

1 Press the **[User Tools/Counter]** key.

The main menu display for default settings appears.

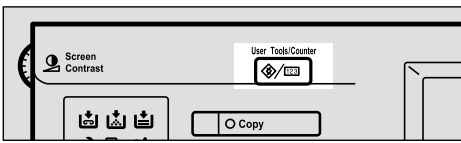

ZHPS180E

Note

- ❑ With a Key Operator Code programmed, changing the default causes the Key Operator Code entry display to appear. If this happens, enter the programmed code first. For the Key Operator Code, see the *General Settings Guide*.

2 Press **[Facsimile Features]**.

The menu display for facsimile default settings appears.

3 Select the item that you want to change.

The corresponding setting display appears.

Reference
p.125 "Function List"

4 Follow the displayed instructions to change the default, and then press **[OK]**.

Note

- ❑ If you make a mistake, press **[Cancel]**.

Quitting Default Settings

1 After changing the defaults, press **[Exit]** on the main menu display for default settings

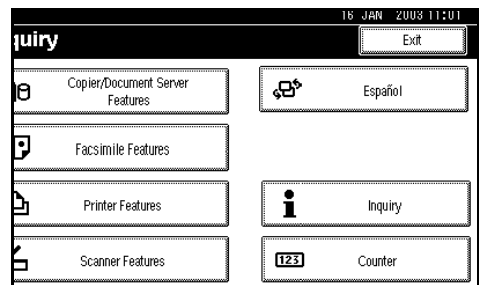

Note

- ❑ You can also press the **[User Tools/Counter]** key again to quit the main menu display for default settings.

General Settings/Adjustment

❖ Switch Memory/Immed. Transmission

Use this function to specify the Transmission Mode for document transmission.

- Memory Transmission
- Immediate Transmission

❖ Text Size Priority

Use this function to specify the character size of your originals for scanning.

- Standard
- Detail

❖ Original Type Priority

Use this function to specify the type of originals for scanning.

- Text
- Text/Photo
- Photo

❖ Auto Image Density

Use this function to prioritize automatic Image Density for scanning your originals.

- ON
- OFF

❖ Adjust Scan Density

Use this function to specify the scan density of your originals.

❖ Select Title

Use this function for selecting the title to be shown on the Destination list.

- Title 1
- Title 2
- Title 3

❖ Change Initial Mode

Use this function to select whether contents registered in program No.1 are to be used as the initial settings after the power is turned on or the **【Clear Modes】** key is pressed:

- Standard
- Program No.1

Note

- You cannot select Program No.1 if program No.1 has not been programmed with priority functions.

❖ Adjust Sound Volume

See p.49 “Adjusting the Volume”, *Facsimile Reference <Basic Features>*.

- On Hook Mode
- At Transmission
- At Reception
- At Dialing
- At Printing

❖ Program Fax Information

See p.41 “Initial Settings and Adjustments”, *Facsimile Reference <Basic Features>*.

- Fax Header
- Own Name
- Own Fax Number

❖ Scan End Reset

Use this function to return to the initial settings each time an original is scanned.

- ON
- OFF

❖ TX Stamp Priority

Use this function to press a TX stamp.

- ON
- OFF

❖ **Line Priority Setting**

Use this function to specify the line of usage.

 **Note**

- The display may differ depending on the line type you have.

❖ **Program Economy Time**

Use this function for specifying a time for transmission when call charges are low. See p.3 “Sending at a Specific Time (Send Later)”.

 **Limitation**

- You can program only one Economy Time.

 **Note**

- If you make a mistake, press **[Clear]** or the **[Clear/Stop]** key before pressing **[OK]**, and then try again.

❖ **On Hook Mode Release Time**

Use this function to specify a time to cancel On Hook mode after you transmit using On Hook dialing. This is helpful when the Fax Information service disconnects your On Hook dialing.

- 1 minute
- 3 minutes
- 5 minutes
- 10 minutes

❖ **Quick Operation Key**

Frequently used functions programmed as Quick Operation Keys are shown on the menu immediately after the power is turned on.

The Quick Operation Keys can be programmed with the following functions:

- Journal
- TX File Status (Transmission File Status)

- Print Conf. RX (Print Confidential Reception)
- Print Memory Lock
- Stored File
- Send Later
- Auto Document
- 2 Sided Original
- Closed Network
- Polling TX (Polling Transmission)
- Polling RX (Polling Reception)
- Fax Header Print
- Label Insertion
- RX Files Status (Reception File Status)
- Forwarding
- Transfer Request
- Switch RX Mode (Reception Mode Switch)
- TX Status Report (Transmission Status Report)

Up to three functions can be programmed into a Quick Operation Keys.

❶ **Select Quick Operation key you want to program.**

❷ **Select the function you want to program in the Quick Operation key**

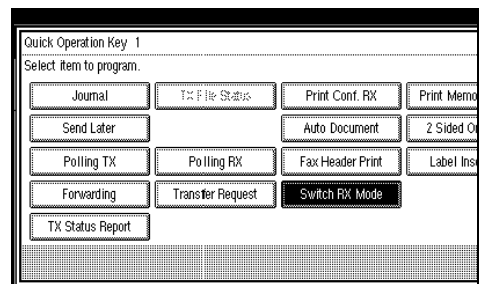

 **Note**

- Functions that appear dimmed have already been set.

Reception Setting

❖ Switch Reception Mode

Specify the method for receiving fax messages.

- Manual Reception
- Auto Reception

❖ Authorized RX (Authorized Reception)

Specify whether or not unwanted fax messages are to be screened out.

- ON
- OFF

❖ Forwarding

Specify whether or not received fax messages are to be forwarded to a registered receiver.

- ON
- OFF

❖ RX File Print Qty (Received-file Print Quantity)

Specify the number of copies to be printed for each fax message received.

- 1 to 10 sets

❖ 2-Sided Print (Available only with the optional duplex unit)

Specify whether or not received fax messages are to be printed on both sides of paper.

- ON
- OFF

❖ RX Reverse Printing (Reception Reverse Printing)

Specify whether or not received fax messages are to be printed from the last page received.

- ON
- OFF

❖ Paper Tray

Use this function to print fax messages received from registered senders and fax messages from other senders, using different paper trays.

- Tray 1
- Tray 2
- Auto Select

❖ Specify Tray for Lines

Specify a paper tray for each line.

- ON
- OFF

① Select **[ON]** to select a paper tray.

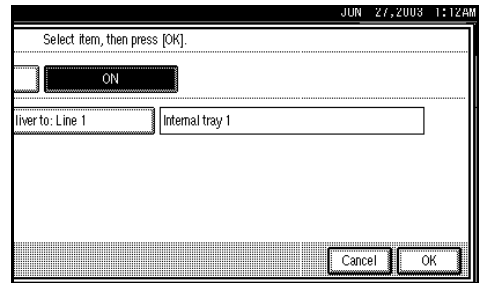

Note

If you select "OFF", the received fax is delivered to a default tray.

② Select the line type.

③ Select a tray to deliver the received paper onto, and then press **[OK]**.

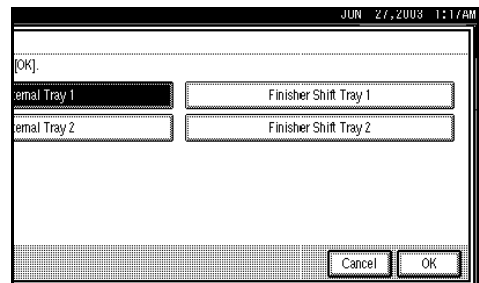

Note

If you want to specify another line type, repeat from step ②.

❖ Checkered Mark

Specify whether or not a checkered mark is to be printed on the first page of received fax messages.

- ON
- OFF

❖ Center Mark

Specify whether or not a center mark is to be printed halfway down the left side and at the top center of each page received.

- ON
- OFF

❖ Print Reception Time

Specify whether or not received date and time are to be printed at the bottom of received fax messages.

- ON
- OFF

9. Key Operator Setting

Key Operator Tools List

You can program, change, or delete standard messages and auto documents. You can also set the line type for the machine connection, register various IDs (including a Polling ID), fax destinations, and many other items. In addition, you can check the number of documents transmitted and received.

Function name	Description	Reference
Programming, changing, and deleting standard messages	You can program, change, or delete standard messages printed at the top of the first page of each incoming message.	p.137 "Programming, Changing, and Deleting Standard Messages"
Programming, changing, and deleting auto documents	You can program, change, or delete pages stored as auto documents.	p.137 "Programming, Changing, and Deleting Standard Messages"
Programming, changing, and canceling scan sizes	You can program, change, or cancel frequently used scan sizes.	p.140 "Programming and Changing a Scan Size"
Printing a Journal	Prints a Journal.	p.23 "Printing the Journal"
Transmission Page Count	Checks the transmission and reception, and totals on the display.	p.142 "Counters"
Forwarding	Transfers received messages to a registered receiver (forwarding destination).	p.143 "Forwarding"
Memory Lock Reception	Switches the Memory Lock to on or off. To use it, register an ID for printing a message received in Memory Lock mode.	p.145 "Memory Lock"
ECM	If part of the transmission fails due to a telephone line fault, this function resends the failed part automatically.	p.146 "ECM"
Parameter Setting	Allows you to change and print the function settings to meet your needs.	p.147 "Changing the User Parameters"
Program Special Sender	By registering particular receivers as Special Sender in advance, you can have Special Senders treated differently.	p.155 "Programming/Changing Special Senders"

Function name	Description	Reference
Box Setting	By using SUB and SEP codes with these functions, you can send messages to another party's box, and retrieve messages stored in boxes.	p.160 "Box Settings"
Transfer Report	Before using Transfer Request, you need this Transfer Report setting.	p.169 "Transfer Report"
Program Confidential ID	Registers an ID required for Confidential communication.	p.170 "Programming a Confidential ID"
Program Polling ID	Registers an ID required for Polling communication.	p.170 "Programming a Polling ID"
Program Memory Lock ID	Registers an ID required for Memory Lock reception.	p.171 "Programming a Memory Lock ID"
Select Dial/Push Phone	Selects a line type when you connect the machine to a G3 analog line.  Note <input type="checkbox"/> This function is not available in some areas.	p.171 "Selecting Dial/Push Phone"
Saving and/or printing received documents	Selects whether received documents are saved on the hard disk to be printed later or printed immediately without being saved.	p.172 "Storing or Printing Received Documents"
Setting the password for viewing received and stored documents	Set the password to view received and stored documents using a Web browser.	p.173 "Setting a User Code for Viewing Received and Stored Documents"

Using Key Operator Settings

Programming, Changing, and Deleting Standard Messages

Use this function to program standard messages to be printed at the top of the first page of the original. It is useful for personalizing messages such as sending greetings.

Note

- You can program three standard messages. You cannot change the "Confidential", "Urgent", "Please phone", or "Copy to corres ..." messages.
- Use the same procedure to program and change your messages.

1 Press the **[User Tools/Counter]** key.

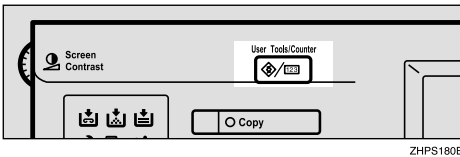

ZHPS180E

2 Select **[Facsimile Features]**.

3 Select **[Key Operator Tools]**.

4 Select **[Program/Change/Delete Standard Message]**.

Programming or changing standard messages

1 Press **[Program/Change]**.

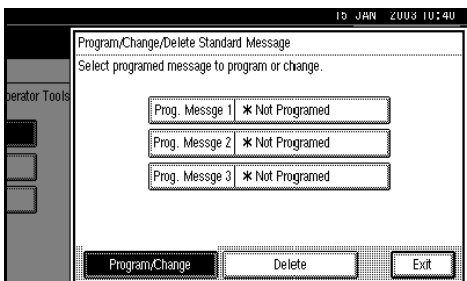

2 Select a message number.

3 Enter your message, and then press **[OK]**.

Reference

"Entering Text", *General Settings Guide*

4 Press **[Exit]**.

Note

- To program another message, repeat the procedure from step 1.
- To cancel a registration, press **[Cancel]**.

5 Press **[Exit]**.

6 Press the **[User Tools/Counter]** key.

The initial display appears.

Deleting Standard Messages

1 Press the **[User Tools/Counter]** key.

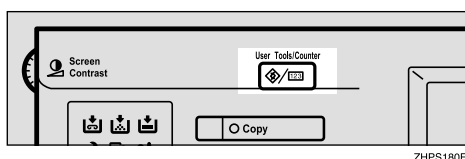

ZHPS180E

2 Select **[Facsimile Features]**.

3 Select **[Key Operator Tools]**.

4 Select **[Store/Change/Delete Auto Document]**.

5 Press **[Delete]**, and then select the message you want to delete.

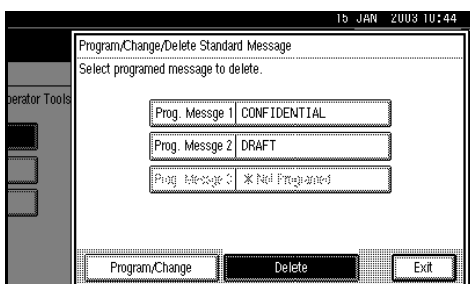

6 Press **[Delete]**.

Note

- To delete another message, repeat from step **5**.
- To cancel a deletion, press **[Do not Delete]**. The display returns to that of step **5**.

7 Press **[Exit]**.

8 Press the **[User Tools/Counter]** key.
The initial display appears.

Storing, Changing, and Deleting an Auto Document

If you often have to send a particular page to people (for example, a map, a standard attachment, or a set of instructions), you can store that page in memory as an Auto Document. This saves rescanning the original every time you want to send it.

Use the following procedure to program a new Auto Document or overwrite an existing one.

You can store the following items in an Auto Document:

- Originals (6 documents maximum; when the optional fax function upgrade unit is installed, 18 documents maximum, only one page per file).
- Scan settings (resolution, original type, and image density)
- Irregular scan area
- Document name (16 characters maximum)

Important

- When about one hour passes after power to the machine is turned off, all fax messages stored in memory are lost. If any messages have been lost for this reason, a Power Failure Report is automatically printed when the operation switch is turned on. Use this report to identify lost messages.

1 Press the **[User Tools/Counter]** key.

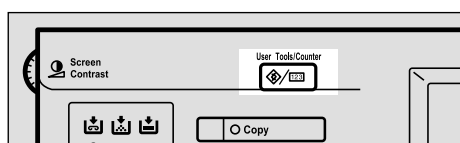

ZHPS180E

2 Select **[Facsimile Features]**.

- 3** Select [Key Operator Tools].
- 4** Select [Store/Change/Delete Auto Document].
- 5** Select and follow the appropriate procedure depending on what you want to perform.

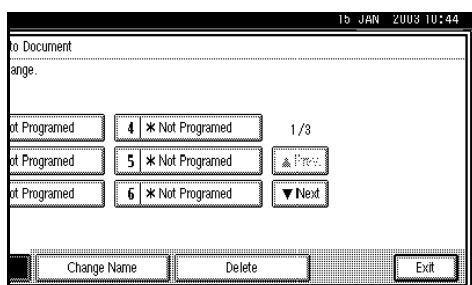

Note

- If there are stored files, the file names are shown.

Storing a file

- 1** Select [***Not programmed**].
- 2** Enter a file name, and then press [OK].

Reference

“Entering Text”, *General Settings Guide*

Changing a file

- 1** Select the file you want to change.

The message “A file is already stored. If another file is stored, previous one will be deleted. Is it OK?” is shown.

- 2** Press [Store].

If you want to cancel storing, press [Do not Store].

Changing only a file name

- 1** Press [Change Name].
- 2** Select the file whose name you want to change.
- 3** Enter a file name, and then press [OK].

Reference

“Entering Text”, *General Settings Guide*

Proceed to step **3**.

- 6** Place the original, and then select any scan settings you require.

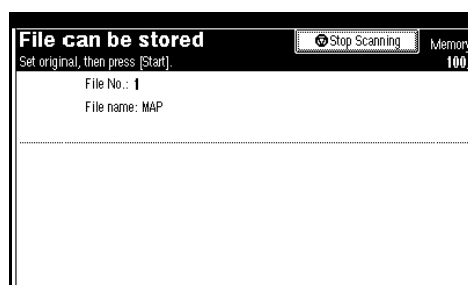

Note

- You can also specify a scan size. See p.14 “Setting a Scan Area”, *Facsimile Reference <Basic Features>*.

- 7** Press the [Start] key.

The machine starts to scan.

Note

- To cancel scanning, press [Stop Scanning].

- 8** Press [Exit] after scanning is finished.

- 9** Press the [User Tools/Counter] key.

The initial display appears.

Deleting an Auto Document

Note

- You cannot delete an Auto Document waiting to be transmitted. Delete it after the transmission or cancel the transmission, and then delete the Auto Document.

1 Press the **[User Tools/Counter]** key.

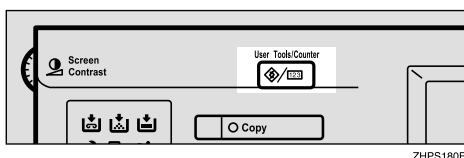

2 Select **[Facsimile Features]**.

3 Select **[Key Operator Tools]**.

4 Select **[Store/Change/Delete Auto Document]**.

5 Press **[Delete]**, and then select the file you want to delete.

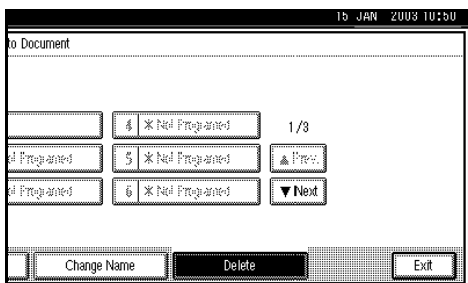

6 Press **[Delete]**.

Note

- To cancel deleting, press **[Do not Delete]**.

7 Press **[Exit]**.

8 Press the **[User Tools/Counter]** key. The initial display appears.

Programming and Changing a Scan Size

When you select a scan size to scan a non-standard size original, two custom sizes are available (Program Size 1 and Program Size 2). Use these functions to program a custom size in advance.

To change an existing scan size, just use the same procedure.

Important

- When programming or changing a scan size, we recommend you make a record of the new size.

Note

- You can specify a horizontal length from 128 to 1,200 mm, or from 5.5 to 47 inches.

1 Press the **[User Tools/Counter]** key.

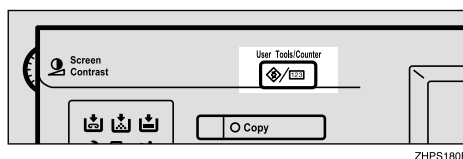

2 Select **[Facsimile Features]**.

3 Select **[Key Operator Tools]**.

4 Select **[Program/Change/Delete Scan Size]**.

5 Press **[Program Size 1]** or **[Program Size 2]**.

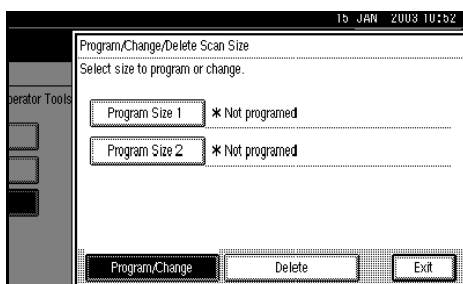

- 6** Enter a horizontal size using the number keys.

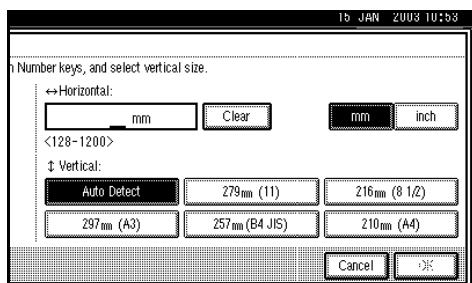

Note

- You can specify a horizontal length from 128 to 1,200 mm or from 5.5 to 47 inches. You cannot specify a length shorter than 128 mm or longer than 1,200 mm.
- Each time you press **[mm]** or **[inch]**, the units switch between "mm" and "inch". If you enter a length and change the units by pressing **[mm]** or **[inch]**, the length is converted automatically according to the unit (fractions are rounded off). For example, when you enter **[2]**, **[5]**, and **[0]** in millimeters and change to "inch", the length "9.8 inch" is shown on the display. If you press **[mm]** or **[inch]** again, "249 mm" is displayed.
- If you make a mistake, press **[Clear]** or the **[Clear/Stop]** key, and then try again.
- To cancel a scan size, press **[Cancel]**.

- 7** Select a vertical size, and then press **[OK]**.

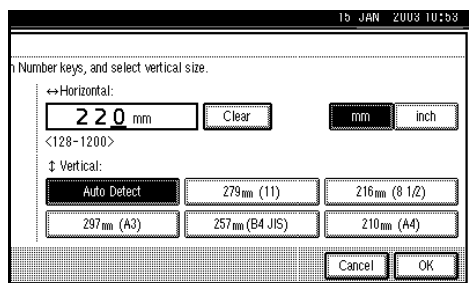

Note

- A displayed vertical size differs depending on the selected unit. When **[mm]** is selected, **[Auto Detect]**, **[210mm (A4)]**, **[257mm(B4 JIS)]**, **[297mm (A3)]**, **[216mm (8 1/2)]**, and **[279mm (11)]** are shown. When **[inch]** is selected, **[Auto Detect]**, **[8.3inch (A4)]**, **[10.1inch(B4 JIS)]**, **[11.7inch (A3)]**, **[8.5inch]**, and **[11.0inch]** are shown.
- To cancel a scan size, press **[Cancel]**.

- 8** Press **[Exit]**.

- 9** Press the **[User Tools/Counter]** key.
The initial display appears.

Deleting a Scan Size

- 1 Press the **[User Tools/Counter]** key.

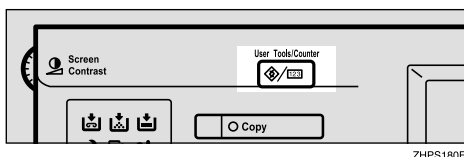

ZHPS180E

- 2 Select **[Facsimile Features]**.
- 3 Select **[Key Operator Tools]**.
- 4 Select **[Program/Change/Delete Scan Size]**.
- 5 Press **[Delete]**, and then select **[Program Size 1]** or **[Program Size 2]**.

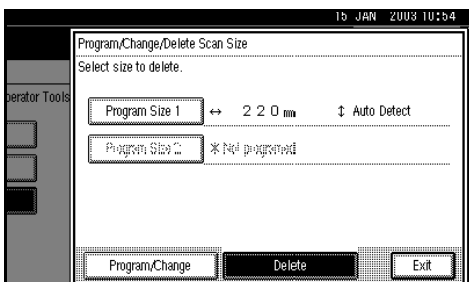

- 6 Press **[Yes]**.

Note

- To cancel deleting, press **[No]**. The display returns to that of step 5.

- 7 Press **[Exit]**.
- 8 Press the **[User Tools/Counter]** key. The initial display appears.

Printing the Journal

The Journal allows you to check a maximum of the last 50 communications (receptions & transmissions) performed by the machine. You can print the Journal using the Information menu. See p.23 "Printing the Journal".

Counters

This function allows you to check the total number of pages transmitted and received on the display.

- Transmissions:
Total number of transmitted pages
- Receptions:
Total number of received pages

- 1 Press the **[User Tools/Counter]** key.

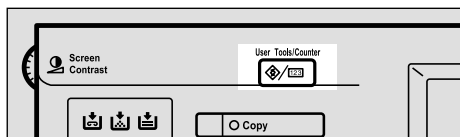

ZHPS180E

- 2 Press **[Facsimile Features]**.
- 3 Select **[Key Operator Tools]**.
- 4 Select **[Transmission Page Count]**.

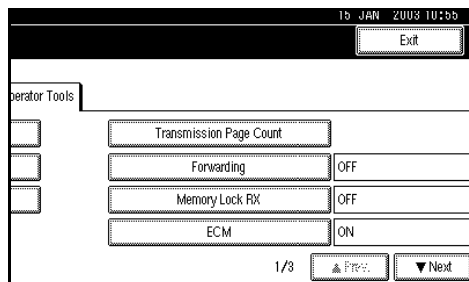

- 5 After checking the display, press **[Exit]**.
- 6 Press the **[User Tools/Counter]** key. The initial display appears.

Forwarding

Using this function, you can have messages from Specified Senders printed on your machine, and then sent to another fax machine.

This is useful if, for example, you are visiting another office and would like a copy of your messages to be sent to that office.

Preparation

To use this function, set **[Forwarding]** under **[Reception Setting]** to “ON (enable)”. See p.132 “Reception Setting”

Limitation

- The Forwarding function does not forward messages received with Confidential Reception, Memory Lock, Polling Reception mode, or messages received by Transfer Request.
- You can select end receivers only from among destinations registered in the Address Book. You cannot specify programmed transfer stations as end receivers.

Note

- If you do not program an end receiver, the machine performs printing but not forwarding even with the Forwarding function On.
- You can program one of the Quick Operation keys with operations for this function. You can then switch the function on or off merely by pressing the Quick Operation key. The function is on when the Quick Operation key has been highlighted.

- If you want to change end receivers separately according to senders, specify end receivers for each special sender in “Special Senders to Treat Differently”. Received messages from unspecified senders will be forwarded to the end receiver specified here. See p.152 “Special Senders to Treat Differently”.
- One receiver only can be specified using this function. For multiple receivers, use Group Dial.
- You can specify whether or not to print forwarded messages. See p.147 “Changing the User Parameters” (switch 11, bit 6).
- Deleting a destination specified as an end receiver from the Address Book causes the settings for the end receiver to be deleted. If this is the case, reprogram the end receiver. If the destination has been changed, a message is transmitted to the new destination.
- You can program one of the Quick Operation keys with operations for this function.

Programming an end receiver

1 Press the **[User Tools/Counter]** key.

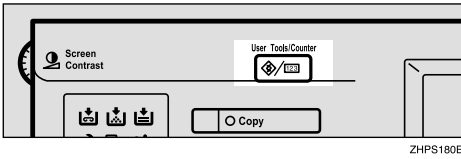

2 Press **[Facsimile Features]**.

3 Select **[Key Operator Tools]**.

4 Select **[Forwarding]**.

5 Press **[ON]**.

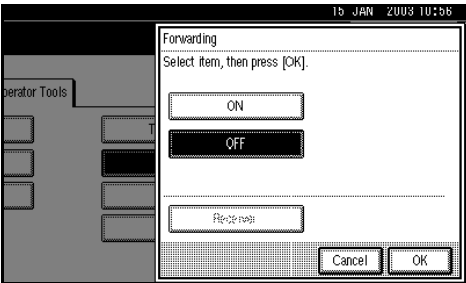

Note

- If there is an end receiver already programmed, a receiver name is shown. If you want to change the receiver, press **[Receiver]** and proceed to step **6**.
- To cancel "Forwarding", press **[Cancel]** and proceed to step **8**.

6 Specify an end receiver using the **Destination list**, and then press **[OK]**.

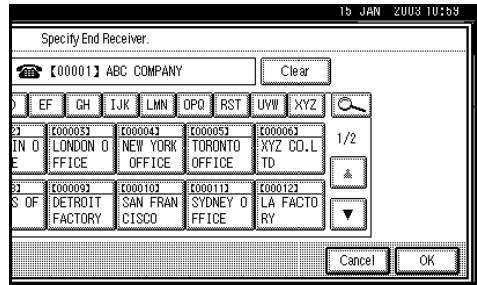

The receiver name is shown to the right of **[Receiver]**.

If you make a mistake, press **[Clear]** or the **[Clear/Stop]** key before pressing **[OK]**, and then try again.

7 Press **[OK]**.

8 Press the **[User Tools/Counter]** key.

The initial display appears.

Quitting the forwarding function

1 Press the **[User Tools/Counter]** key.

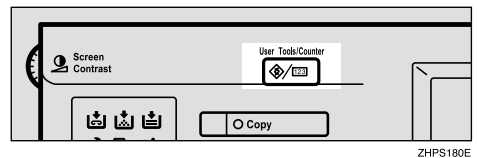

2 Press **[Facsimile Features]**.

3 Select **[Key Operator Tools]**.

4 Select **[Forwarding]**.

- 5** Press [OFF], and then press [OK].

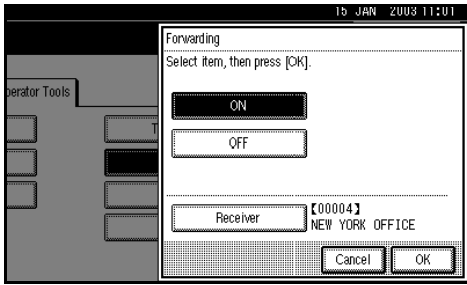

- 6** Press the **[User Tools/Counter]** key.
The initial display appears.

Forwarding mark

You can print a Forwarding Mark on the receiver's messages that have been forwarded.

The receiver can distinguish between forwarded messages and usual receptions.

Note

- You can specify whether or not to print a Forwarding Mark in the User Parameters. See p.147 "Changing the User Parameters" (switch 02, bit 0).

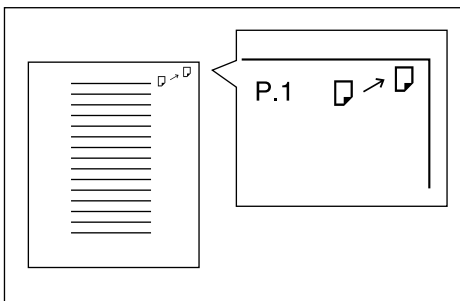

GFMTE00E

Memory Lock

When you switch Memory Lock on, received messages are stored in memory and not printed automatically. When a message is received in the Memory Lock mode, the Confidential File () indicator blinks. To print this message, enter the Memory Lock ID. A user without the ID cannot print the message. This prevents unauthorized users from seeing the message.

Preparation

To use Memory Lock, program the Memory Lock ID, and then switch Memory Lock on. See p.171 "Programming a Memory Lock ID".

Note

- To store incoming documents from Special Senders only in Memory Lock, program each sender with "Special Senders to Treat Differently". See p.152 "Special Senders to Treat Differently".

- 1** Press the **[User Tools/Counter]** key.

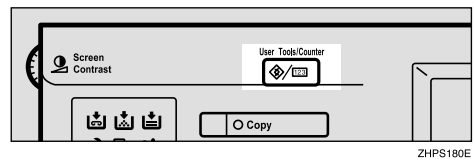

- 2** Press **[Facsimile Features]**.

- 3** Select **[Key Operator Tools]**.

- 4** Select **[Memory Lock RX]**.

- 5** Select [ON] or [OFF], and then press [OK].

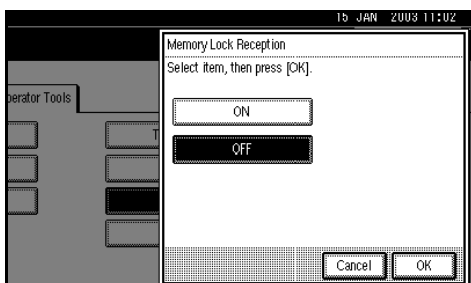

Note

- To cancel this setting, press [Cancel]. The display returns to that of step 4.

- 6** Press the [User Tools/Counter] key.
The initial display appears.

ECM

If part of a transmission fails because of a line problem, the lost data is automatically resent. For this function to work, the other machine must have ECM. You can turn this function on or off through the following procedure.

Note

- If you turn ECM off, you cannot use the following functions:
 - JBIG Transmission
 - Super G3 Communication

- 1** Press the [User Tools/Counter] key.

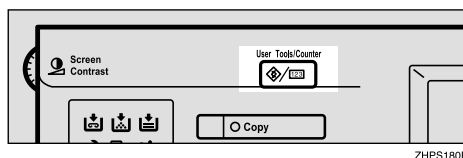

- 2** Press [Facsimile Features].

- 3** Select [Key Operator Tools].

- 4** Select [ECM].

- 5** Select [ON] or [OFF], and then press [OK].

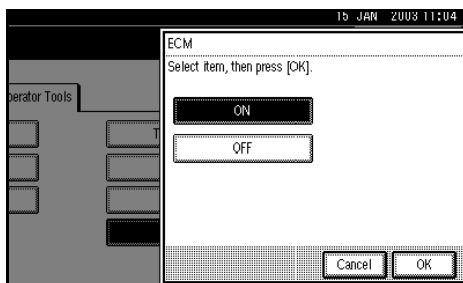

Note

- To cancel this setting, press [Cancel]. The display returns to that of step 4.

- 6** Press the [User Tools/Counter] key.
The initial display appears.

Changing the User Parameters

User Parameters allow you to customize various settings to suit your needs. To change function settings, set the User Parameter Switches.

Preparation

Access to some User Parameter Settings requires installation of optional equipment, or that other settings be made beforehand.

Switches and Bits

Each User Parameter has a set of switches, and each of the switches consist of eight bits, whose values are “0” or “1”. The right most bit is bit 0 and the left most is bit 7. You can adjust the settings to match your needs by switching the value of bits between “0” and “1”.

Switch 02	0	0	1	1	1	0	1	1
	↓	↓	↓	↓	↓	↓	↓	↓
	7	6	5	4	3	2	1	0

 **User Parameter List**

User Parameter Switches are outlined below.

Switch	Bit	Item	0	1
02	0	Forwarding Mark	Off	On
	3	TSI Print	Off	On
03	0	Automatic printing of the Memory Transmission Result Report	Off	On
	2	Automatic printing of the Memory Storage Report	Off	On
	3	Automatic printing of the Polling Reception Reserve Report	Off	On
	4	Automatic printing of the Polling Reception Result Report	Off	On
	5	Automatic printing of the Immediate Transmission Result Report	Off	On
	6	Automatic printing of the Polling Transmission Clear Report	Off	On
	7	Automatic printing of the Journal	Off	On
04	0	Automatic printing of the Confidential File Report	Off	On
	7	Include a portion of the image on the Transmission Result Report (Memory Transmission), Memory Storage Report, Communication Failure Report, or Transfer Result Report (Inclusion of part of image)	Off	On

Switch	Bit	Item	0	1
05	0	Receive Service Call (SC) Condition (Substitute Reception during service call)	Possible (Substitute RX)	Not possible (Reception off)
	2, 1	Substitute the reception when the machine cannot print (because all paper trays have run out of paper, toner is empty, or all paper trays are out of order) 00: Enabled unconditionally (Free) 01: Enabled when Own Name/Own Fax Number is received 10: Enabled for Polling ID match 11: Disabled (Reception off)		
	5	Just Size Printing	Off	On
	7	Empty cassette alert (Paper Empty Warning indication)	Off	On
06	6	First page scanned for book originals	From the left page	From the right page
07	2	Parallel Memory Transmission	Off	On
08	2	Authorized Reception Type	Receiving from only specified senders	Receiving all messages except those from specified senders
10	1	Combine two originals	Off	On
	3	Page reduction when printing	Off	On
11	6	Local print when forwarding	Off	On
	7	Polling file after sending (Polling transmission standby time)	Delete (Use Once)	Standby (Save)
14	0	Print documents received with Auto Power-On Reception (Night Printing mode)	Immediate printing (Off)	When turning on the operation switch (On)
	1	Long Document Transmission (Well Log)	Off	On
	2	Batch Transmission	Off	On
	3	Reset when function changed	Off	On
	7	System Parameter List Transmission	Off	On
17	2	Whether you need to press [Add] after entering a Quick Dial/Group Dial when broadcasting	Not necessary	Necessary
	7	Receive messages by pressing the [Start] key when originals are not set.	Off (The machine does not receive messages by pressing the [Start] key.)	On (The machine receives messages by pressing the [Start] key.)

Switch	Bit	Item	0	1
18	0	Print date with Fax Header	Off	On
	1	Print transmitter origin with Fax Header	Off	On
	2	Print file number with Fax Header	Off	On
	3	Print page number with Fax Header	Off	On
19	0	Use paper delivery shift function (Offset Print)	Off	On
	1	Sort Journal by line type	Off	On
20	0	Automatic printing of the LAN-Fax Error Report	Off	On
	1	Reprint documents that could not be printed using LAN-Fax Driver	Off	On
	5, 4, 3, 2	Store documents in memory that could not be printed using LAN-Fax Driver 0000: 0 minute / 0001: 1 minute / 0010: 2 minutes / 0011: 3 minutes / 0100: 4 minutes / 0101: 5 minutes / 0110: 6 minutes / 0111: 7 minutes / 1000: 8 minutes / 1001: 9 minutes / 1010: 10 minutes / 1011: 11 minutes / 1100: 12 minutes / 1101: 13 minutes / 1110: 14 minutes / 1111: 15 minutes		
24	1, 0	Store a message in memory that could not be transmitted 00: Off, 01: Store for 24 hours, 11: Store for 72 hours		
25	4	RDS	Off	On

Changing the User Parameters

Important

- ❑ We recommend you print and keep a User Parameter list when you program or change a User Parameter. See p.152 “Printing the User Parameter list”.
- ❑ Do not change any bit switches other than those shown on the previous pages.

1 Press the **[User Tools/Counter]** key.

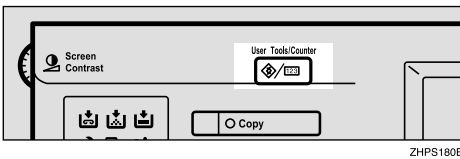

2 Press **[Facsimile Features]**.

3 Select **[Key Operator Tools]**.

4 Select **[Parameter Setting]**.

5 Select the switch number you want to change.

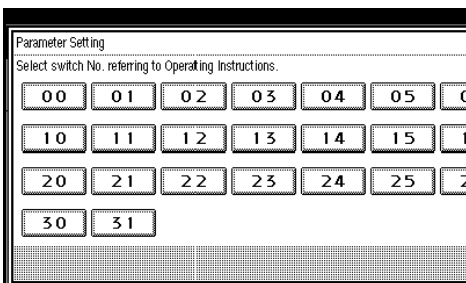

6 Select the bit number you want to change.

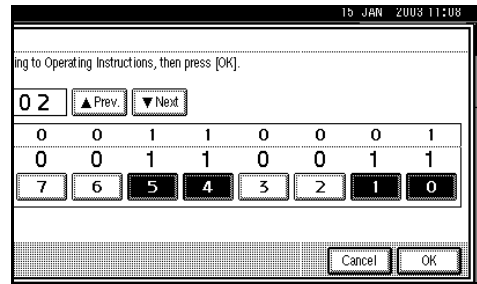

When the bit number is pressed, the current value switches between 1 and 0.

Note

- ❑ Repeat from step **6** to change another bit number for the same switch.

7 Press **[OK]**.

Note

- ❑ To cancel these settings, press **[Cancel]**. The display returns to that of step **5**.

8 Repeat steps **5** and **6** to change the switch settings.

9 After all the settings are finished, press **[Exit]**.

10 Press the **[User Tools/Counter]** key.

The initial display appears.

Printing the User Parameter list

Print this list to see the current User Parameter settings.

- 1 Press the **[User Tools/Counter]** key.

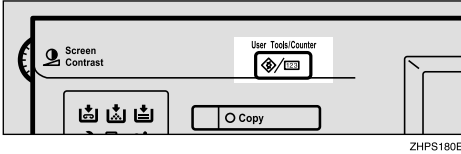

- 2 Press **[Facsimile Features]**.
- 3 Select **[Key Operator Tools]**.
- 4 Press **[Print List]** next to **[Parameter Setting]**.

Note

- To cancel printing a list, press **[Cancel]**. The display returns to that of step 4.

- 5 Press the **[Start]** key.

Note

- To cancel printing a list, press **[Cancel]**. The display returns to that of step 4.

- 6 Press the **[User Tools/Counter]** key.

The initial display appears.

Special Senders to Treat Differently

By programming particular receivers in advance, you can set the following function for each receiver:

- Authorized RX (Authorized Reception)
- Forwarding
- Reception File Print Qty
- Print 2 sided
- Memory Lock
- RX Reverse Printing (Reception Reverse Printing)
- Paper Tray

Use the Own Name or Own Fax Number to program your receivers. If the receiver has a machine of the same manufacturer, program an Own Name that has already been programmed as a receiver. If the machine is not of the same manufacturer, use Own Fax Number. You can apply the same settings to all programmed numbers. You can then customize the settings for individual numbers as necessary using the Special Sender Registration function.

The following items can be programmed.

- Special Senders (Up to 30. A maximum of 50 when the optional fax function upgrade unit is installed. A maximum of 20 characters for each name when using G3.)
- Full/ Partial agreement
When you program own names and facsimile names for multiple destinations, you can program a common sequence of characters to identify destinations using Partial agreement.

❖ Using a Full agreement

Destination to be registered (Own Name)	Number of registered identifications
NEW YORK BRANCH	3
HONG KONG BRANCH	
SYDNEY BRANCH	

❖ Using a Partial agreement

Destination to be registered (Own Name)	Number of registered identifications
BRANCH	1

Note

- You can program up to 30 wild cards (50 with the optional fax function upgrade unit).
- Spaces are ignored when identifications are compared.
- You can use wild cards for the following functions:
 - See p.155 “Programming/Changing Special Senders”.
 - See p.156 “Authorized RX (Authorized Reception)”.
 - See p.156 “Forwarding”.

Limitation

- You cannot register senders as Special Senders if they do not have Own Name or Own Fax Number programmed.
- The machine cannot differentiate between Polling Reception and Free Polling documents from Special Senders.

Note

- You can program up to 24 characters for the sender.
- You can check Own Name and Own Fax Number using the Journal. You can check programmed Special Senders using the specified sender list. See p.23 “Printing the Journal”. See p.160 “Printing the Special Sender list”.
- If you select “OFF” for the Special Sender function in “Initial Set Up”, the settings will be the same as the Reception Mode settings. See p.132 “Reception Setting”.

❖ Authorized Reception

Use this function to limit incoming senders. The machine only receives faxes from programmed Special Senders, and therefore, it helps you screen out unwanted messages, such as junk mail, and saves wasting fax paper.

Note

- To use this function, program the Special Senders function, and then select “ON” in “Authorized RX” with “Reception Setting”. See p.132 “Reception Setting”. See p.147 “Changing the User Parameters” (switch 08, bit 2).
- Without registering Special Senders, the Authorized RX function will not work, even if you select “ON”.
- You can select to receive only from registered senders or receive only from senders other than those registered in “User Parameters”. See p.147 “Changing the User Parameters” (switch 08, bit 2).

- If you select "OFF" for Authorized RX in "Initial Set Up", the settings will be the same as the Reception Mode settings. See p.132 "Reception Setting".
- You can change Special Senders in the same way as you program them.

❖ Forwarding

Use this function to print received messages, and then transfer them to those receivers registered beforehand.

It is also possible to forward faxes sent only by senders programmed as Special Senders.

Note

- To use this function, register your Special Senders, and then select "ON" for "Forwarding" in "Reception Setting". See p.132 "Reception Setting".
- If you specify "ON" in "Forwarding" and select [**Same as basic settings**], the fax message will be forwarded to the other ends programmed in "Specify End Receiver". See p.143 "Forwarding".
- If you do not program any Special Senders, the machine transfers all incoming documents to the other end specified in "Specify end Receiver".

❖ Reception File Print Quantity

Use this function to print the specified number of copies of documents received from programmed senders (Special Senders). If you do not register any Special Senders, the machine prints the specified number of copies for all received documents.

Limitation

- You cannot use multi-copy printing with Polling Reception, Free Polling, Confidential Reception, or Memory Lock.

Note

- You can specify up to 10 copies.

❖ Print 2 Sided

The optional duplex unit is required.

Use this function to print on both sides of paper.

Limitation

- If you select the bypass tray for the "Paper Tray", duplex printing is disabled.

❖ Memory Lock

Use this function to store incoming documents from registered senders (Special Senders) in memory without printing them. People without the Memory Lock ID cannot print the documents, and therefore this function is useful for receiving confidential documents. If you do not register any senders, the machine receives fax message from all senders using Memory Lock reception.

Reference

p.171 "Programming a Memory Lock ID"

Limitation

- If you program the same sender in Memory Lock and Forwarding, Forwarding is disabled.

❖ Reception Reverse Printing

Use this function to print the pages in reverse order. See p.88 "Reverse Order Printing".

❖ Paper Tray

Use this function to print documents received from registered senders (Special Senders) and the documents from other senders on different types of paper.

For example, if blue paper is in Tray 1 and white paper is in Tray 2, the machine prints the documents from Special Senders on the blue paper and prints the documents from other senders on the white paper, making it easy for you to separate the two.

If you do not program any Special Senders, the machine outputs documents received from all senders using the default paper tray.

📍 Limitation

- For Polling Reception and Free Polling, you cannot select the paper tray.

📝 Note

- If the machine receives a message that has a different size from the paper in the specified tray, the machine prints it after splitting it or minimizing its size. See p.88 “Page Separation and Length Reduction”.
- Selection of the bypass tray (optional) enables you to specify the paper size in “Scan Area”.

Programming/Changing Special Senders

- 1** Press the **[User Tools/Counter]** key.

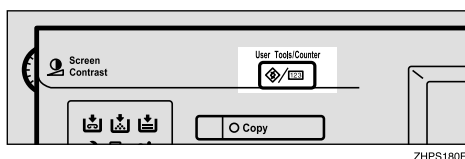

ZHPS180E

- 2** Press **[Facsimile Features]**.

- 3** Select **[Key Operator Tools]**.

- 4** Select **[Program Special Sender]**.

- 5** Select the destination to program.

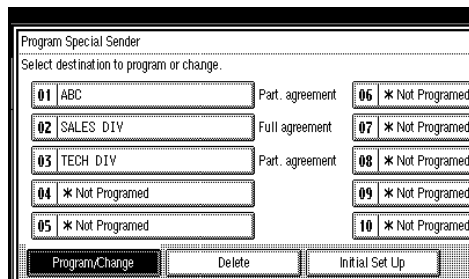

- 6** Enter a destination, and then press **[OK]**.

Enter a destination using Own Name or Own Fax Number.

🔍 Reference

“Entering Text”, *General Settings Guide*

- 7** When selecting the condition, press **[Full agreement]** or **[Partial agreement]**.

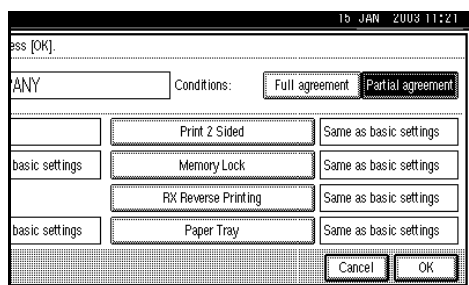

- 8** Select the item you want to program.

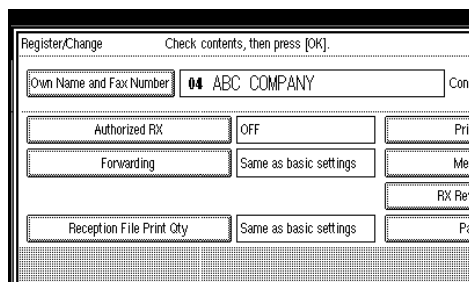

Note

- You must select only the item you want to program.
- If you select [**Same as basic settings**], the settings will be the same as [**Reception Setting**] (See p.132 “Reception Setting”), [**Forwarding**] (See p.143 “Forwarding”), and [**Memory Lock**] (See p.145 “Memory Lock”).
- To cancel these settings, press [**Cancel**]. The display returns to that of step 5.

Authorized RX (Authorized Reception)

- 1 Press [**Authorized RX**].
- 2 Select [**ON**] or [**OFF**], and then press [**OK**].

Forwarding

- 1 Press [**Forwarding**].
- 2 Select [**ON**] or [**OFF**].

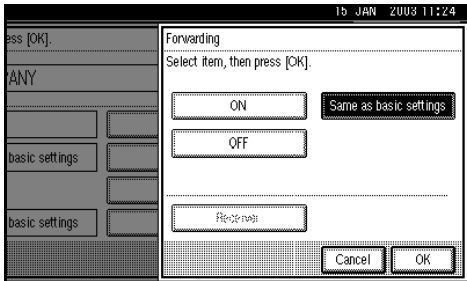

If you select [**OFF**], proceed to step 4.

Note

- Selecting [**Same as basic settings**] will result in the same setting made for [**Forwarding**] immediately under [**Key Operator Tools**].

3 Specify an end receiver.

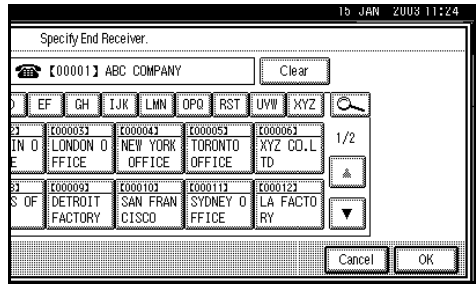

4 Press [**OK**].

5 Press [**OK**].

If you select [**Yes**], the name of the end receiver appears to the right of “Receiver :”.

Reception File Print Qty

- 1 Press [**Reception File Print Qty**].
- 2 Select [**Number of Sets**].

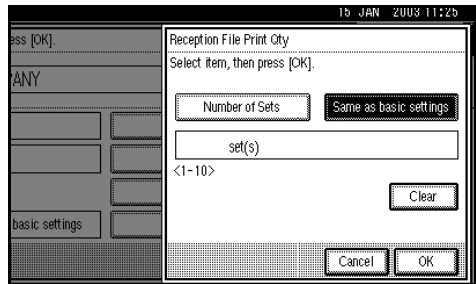

3 Enter the print quantity using the number keys, and then press [**OK**].

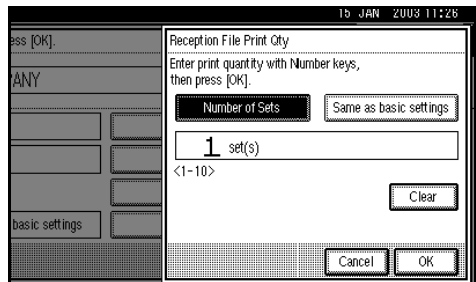

Note

- If you make a mistake, press [**Clear**] or the [**Clear/Stop**] key before pressing [**OK**], and then try again.

Print 2 Sided

- 1 Press [Print 2 Sided].
- 2 Select [ON] or [OFF], and then press [OK].

Memory Lock

- 1 Press [Memory Lock].
- 2 Select [ON] or [OFF], and then press [OK].

RX Reverse Printing (Reception Reverse Printing)

- 1 Press [RX Reverse Printing].
- 2 Select [ON] or [OFF], and then press [OK].

Paper Tray

- 1 Press [Paper Tray].
- 2 Select the tray you want to use, and then press [OK].

 **Note**

- Selecting [Same as basic settings] will result in the same setting made for [Paper Tray] immediately under [Reception Setting].

- 9 Press [OK].

A Special Sender has been programmed.

 **Note**

- To program another sender, repeat the procedure from step 5.

- 10 Press [Exit].

- 11 Press the [User Tools/Counter] key.

The initial display appears.

Programming Initial Set Up of a Special Sender

Use this function to program “Initial Set Up” of a Special Sender. You can also specify the Bypass Tray Paper Size.

- 1 Press the [User Tools/Counter] key.

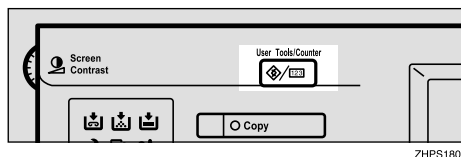

- 2 Press [Facsimile Features].

- 3 Select [Key Operator Tools].

- 4 Select [Program Special Sender].

- 5 Press [Initial Set Up].

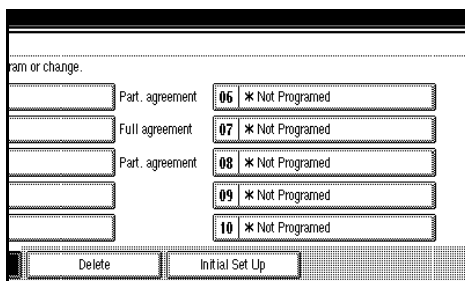

- 6 Select the function you want to program.

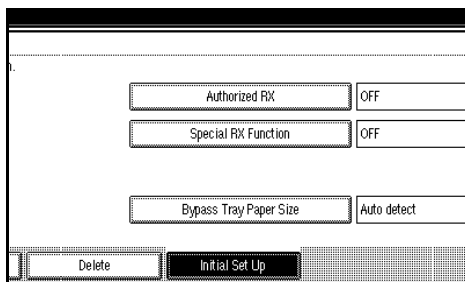

Note

- In this feature, “Authorized RX” has the same settings as “Reception Setting”. See p.132 “Reception Setting”.

Programming Authorized RX and Special RX Function

- 1 Press **[Authorized RX]** or **[Special RX Function]**.
- 2 Select **[ON]** or **[OFF]**, and then press **[OK]**.

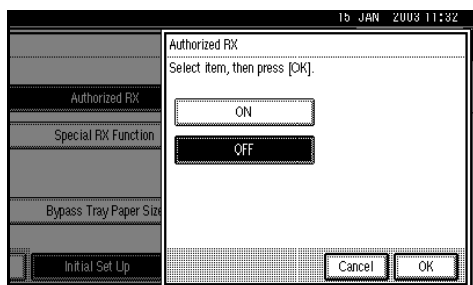

The illustration shows the “Authorized RX” display as an example.

Programming Bypass Tray Paper Size

- 1 Press **[Bypass Tray Paper Size]**.

You can select a size from **[Auto Detect]**, **[Standard Size]**, or **[Custom Size]**.

If you select **[Auto Detect]**, proceed to steps 2 and 7.



If you select **[Standard Size]**, proceed to steps 2, 3, and 7.

If you select **[Custom Size]**, proceed to steps 2, and 4 to 7.

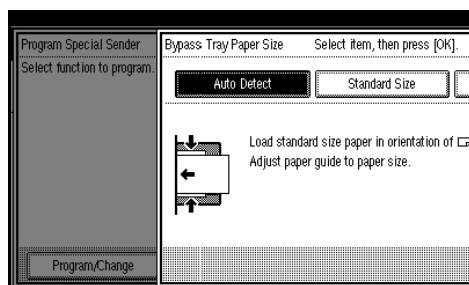
- 2 Select the size you want to program.

**Note**

- If you select **[Auto Detect]**, the machine recognizes the paper size automatically.

- The machine will detect the paper size for the bypass tray as the short edge of the paper is inserted into the machine. Even if you placed an A4 size sheet in the  orientation, the machine will detect it as A3 .

- If you select **[Standard Size]**, select a paper size displayed, and then proceed to step 7.
- If you select **[Custom Size]**, proceed to step 4.

- 3 Select the size you want to program from the sizes shown.

- 4 Make sure that **[Vertical]** is selected.

Note

- If **[Vertical]** has not been selected, press **[Vertical]**.

- 5 Enter the vertical size of the paper using the number keys, and then press [**#**].

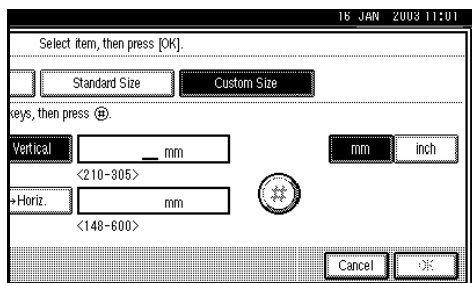

Note

- You can specify a vertical size from 210 mm (8.3 inch) to 305 mm (12.0 inch). You cannot enter a size smaller than 210 mm or larger than 305mm.
- Each time you press [**mm**] or [**inch**], the units switch between “mm” and “inch”. If you enter a length and change the units by pressing [**mm**] or [**inch**], it is converted automatically (fractions are rounded off).

- 6 Enter the horizontal size of the paper using the number keys, and then press [**#**].

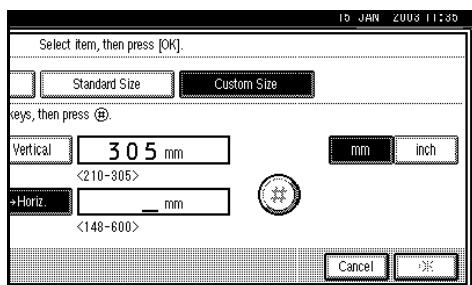

Note

- You can specify a horizontal size from 148 mm (5.8 inch) to 600 mm (23.6 inch). You cannot enter a size smaller than 148 mm or larger than 600 mm.
- Each time you press [**mm**] or [**inch**], the units switch between “mm” and “inch”. If you enter a length and change the units by pressing [**mm**] or [**inch**], it is converted automatically (fractions are rounded off).

- 7 Press [**OK**].

- 7 Press [**Exit**].

- 8 Press the [**User Tools/Counter**] key.
The initial display appears.

Deleting a Special Sender

Use this function to program “Initial Set Up” of a Special Sender. The Bypass Tray Paper Size can also be specified.

- 1 Press the [**User Tools/Counter**] key.

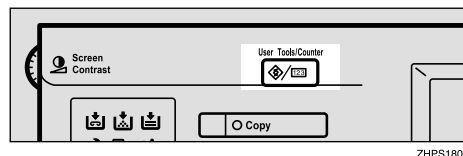

- 2 Press [**Facsimile Features**].

- 3 Select [**Key Operator Tools**].

- 4 Select [**Program Special Sender**].

- 5 Press [**Delete**], and then select the Special Sender you want to delete.

6 Press **[Delete]**.

 **Note**

- To cancel deleting a special sender, press **[Do not Delete]**. The display returns to that of step **5**.

7 Press **[Exit]**.

8 Press the **[User Tools/Counter]** key.
The initial display appears.

Printing the Special Sender list

1 Press the **[User Tools/Counter]** key.

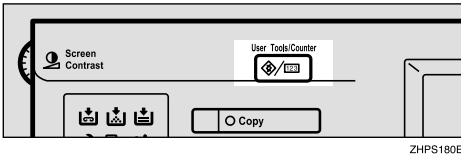

2 Press **[Facsimile Features]**.

3 Select **[Key Operator Tools]**.

4 Press **[Print List]** next to "Program Special Sender".

 **Note**

- To cancel printing, press **[Cancel]**. The display returns to that of step **4**.

5 Press the **[Start]** key.

 **Note**

- To cancel printing after pressing the **[Start]** key, press **[Stop Printing]**. The display returns to that of step **4**.

6 Press the **[User Tools/Counter]** key.
The initial display appears.

Box Settings

The following functions are for delivery and transfer of messages:

- Personal Box
- Information Box
- Transfer Box

By using SUB and SEP codes with these functions, you can send messages to another party's box and retrieve messages stored in boxes.

For details about how to set up these functions:

See p.161 "Programming/editing Personal Boxes".

See p.163 "Programming/editing Information Boxes".

See p.165 "Programming/editing Transfer Boxes".

For details about how to print out and delete messages stored in boxes:

See p.36 "Before using this function, set the Personal Box in advance. See p.161 "Programming/editing Personal Boxes"."

See p.38 "Information Boxes".

 **Note**

- The combined total of items that can be stored using the Personal Box, Information Box, and Transfer Box functions is 150. Installing the optional fax function upgrade unit increases this capacity to 400.
- SUB and SEP codes can be up to 20 digits long and contain numbers, spaces, pound signs (#), and asterisks (*).

 **Limitation**

- You cannot set the same Box code on two different boxes.

- ❑ Transmission or programming may not be allowed if there is not enough free memory left. The amount of free memory left differs depending on the optional equipment installed.

Programming/editing Personal Boxes

This section describes how to program Personal Boxes.

You can store the following items:

- Box name (required)
Up to 20 characters long
- SUB code (required)
Up to 20 characters long and can be composed of digits 0-9, "#", "*", and spaces (the first character cannot be a space).
- Password (optional)
Up to 20 characters long and can be composed of digits 0-9, "#", "*", and spaces (the first character cannot be a space).
When registering a password, a mark is displayed before the Box name.
- Receiver (optional)
You can program one delivery destination for each Personal Box. Specify a delivery destination programmed in Quick Dial.

Note

- ❑ The contents of the Personal Box will be saved until printing is completed.
- ❑ The Fax Header is not printed on delivered messages.
- ❑ If a message cannot be delivered, a Communication Failure Report is printed and the message is saved as a Confidential Reception document.

- ❑ You can edit boxes in the same way you program them. However, to change the SUB code itself, you must delete the box, and then program a new SUB code.
- ❑ If the fax number of a programmed receiver is deleted using System Settings, the setting for the receiver is cancelled and a message is not delivered. If the fax number of a programmed receiver is changed, a message is delivered to the new fax number.

Reference

p.36 "Before using this function, set the Personal Box in advance. See p.161 "Programming/editing Personal Boxes"."

- 1 Press the **[User Tools/Counter]** key.

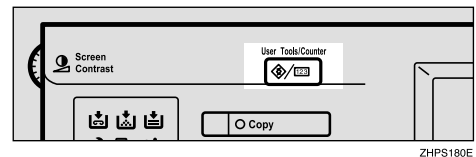

- 2 Press **[Facsimile Features]**.

- 3 Select **[Key Operator Tools]**.

- 4 Select **[Box Setting]**.

- 5 Select a box to program.

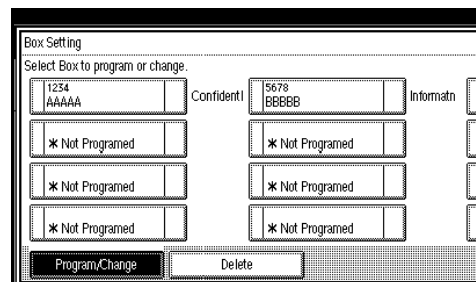

When programming a new box, press **[*Not Programed]**.

Note

- ❑ To change a box already programmed, press it and proceed to step 3.

6 Press **[Personal Box]**.

7 Enter a Box name, and then press **[OK]**.

Reference

“Entering Text”, *General Settings Guide*

8 Enter a SUB code.

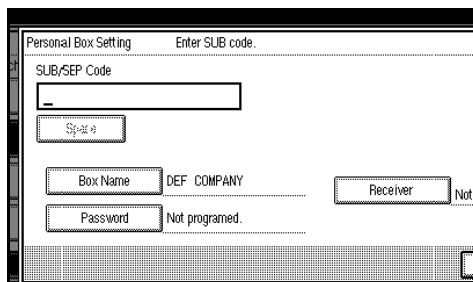

Note

- To change the SUB code, press **[Clear]** or the **[Clear/Stop]** key, and then try again. To change a Box name, press **[Box Name]**, and then repeat the procedure from step **7**.

9 Specify the settings you require.

If you do not want to program a password or receiver, proceed to step **10**.

Programming a password

1 Press **[Password]**.

2 Enter a password, and then press **[OK]**.

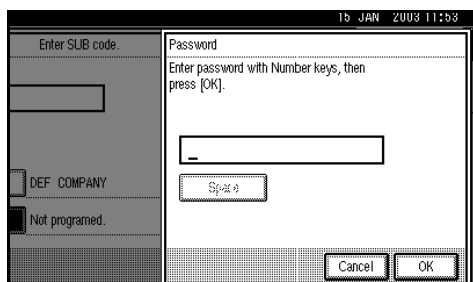

Note

- If you make a mistake, press **[Clear]** or the **[Clear/Stop]** key before pressing **[OK]**, and then try again.

Programming a receiver

1 Press **[Receiver]**.

2 Select a destination using the Quick Dial Table, and then press **[OK]**.

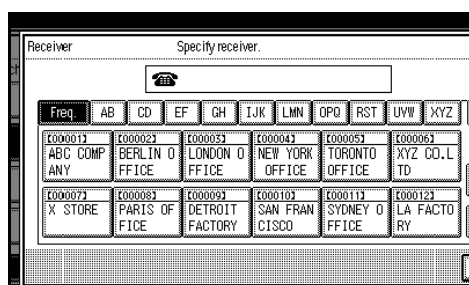

10 Press **[OK]**.

11 Press **[Exit]**.

12 Press the **[User Tools/Counter]** key.
The initial display appears.

Deleting Personal Boxes

This section describes how to delete Personal Boxes.

Limitation

- If messages have been programmed in the box, you cannot delete the box.

1 Press the **[User Tools/Counter]** key.

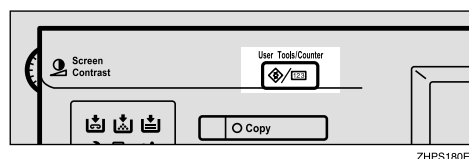

2 Press **[Facsimile Features]**.

- 3** Select [Key Operator Tools].
- 4** Select [Box Setting].
- 5** Press [Delete], and then select the box you want to delete.

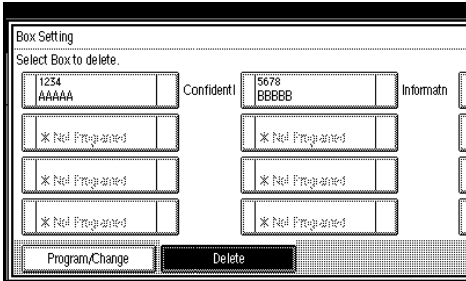

With a programmed password

- 1** Enter a password using the number keys, and then press [OK].

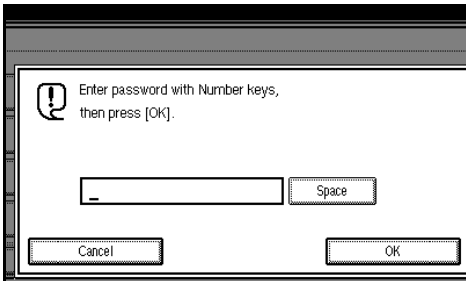

- 6** Press [Delete].

Note

- To cancel deleting a box, press [Do not Delete]. The display returns to that of step **5**.

- 7** Press [Exit].

- 8** Press the [User Tools/Counter] key.
The initial display appears.

Programming/editing Information Boxes

This section describes how to set up an Information Box.

You can store the following items:

- Box name (required)
Up to 20 characters long
- SEP code (required)
Up to 20 characters long and can be composed of digits 0-9, "#", "*", and spaces (the first character cannot be a space).
- Password (optional)
Up to 20 characters long and can be composed of digits 0-9, "#", "*", and spaces (the first character cannot be a space).
When registering a password, a mark is displayed before the Box name.

Note

- You can edit boxes in the same way you program them. However, to change the SEP Code itself, you must delete the box, and then program a new SEP Code.

Reference

p.38 "Information Boxes"

- 1** Press the [User Tools/Counter] key.

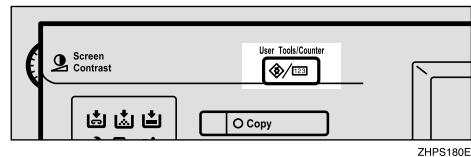

- 2** Press [Facsimile Features].

- 3** Select [Key Operator Tools].

- 4** Select [Box Setting].

5 Select the box to program.

When programming a new box, press **[*Not Programed]**.

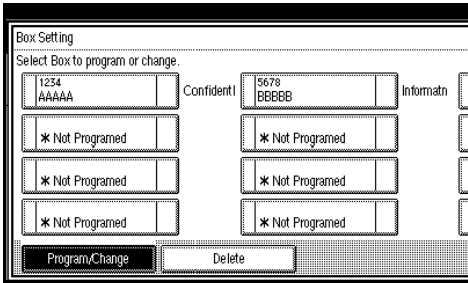

Note

- To change a box already programmed, press it, and then proceed to step **3**. If a password has been programmed, enter the password, press **[OK]**, and then proceed to step **3**.

6 Press **[Information Box]**.

7 Enter a Box name, and then press **[OK]**.

Reference

“Entering Text”, *General Settings Guide*

8 Enter the SEP code.

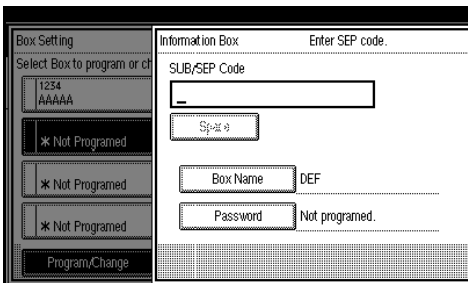

Note

- To change the SEP code, press **[Clear]** or the **[Clear/Stop]** key, and then try again. To change the box name, press **[Box Name]**, and then repeat the procedure from step **7**.

9 Press **[Password]**.

Note

- If you do not want to program a password, proceed to step **11**.

10 Enter a password, and then press **[OK]**.

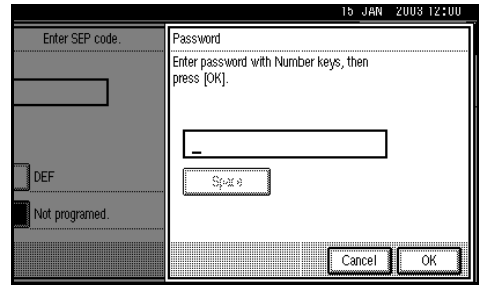

Note

- If you make a mistake, press **[Clear]** or the **[Clear/Stop]** key before pressing **[OK]**, and then try again.

11 Press **[OK]**.

12 Press **[Exit]**.

13 Press the **[User Tools/Counter]** key. The initial display appears.

Deleting Information Boxes

This section describes how to delete Information Boxes.

Limitation

- If messages have been programmed in the box, you cannot delete the box.

1 Press the **[User Tools/Counter]** key.

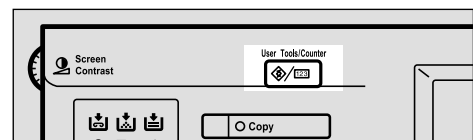

ZHPS180E

- 2 Press [Facsimile Features].
- 3 Select [Key Operator Tools].
- 4 Select [Box Setting].
- 5 Press [Delete], and then select the box you want to delete.

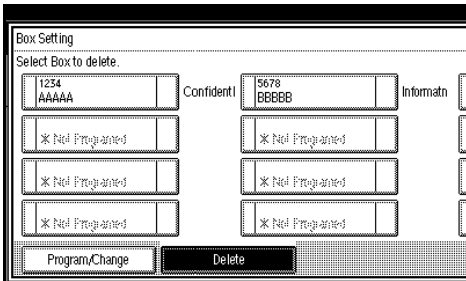

With a programmed password

- 1 Enter a password using the number keys, and then press [OK].

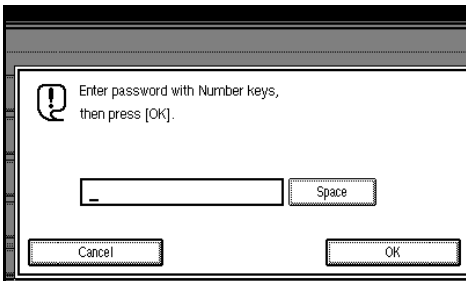

- 6 Press [Delete].

Note

- To cancel deleting a box, press [Do not Delete]. The display returns to that of step 5.

- 7 Press [Exit].

- 8 Press the [User Tools/Counter] key. The initial display appears.

Programming/editing Transfer Boxes

This function turns your machine into a fax relay station. Documents sent with a SUB code that matches the SUB code programmed as a Transfer Box are received, and then relayed to a registered receiver.

Since documents can be sent to multiple destinations in a single transfer request, you can economize on call charges when sending to remote destinations.

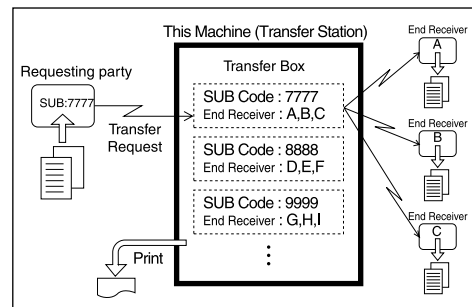

GFCYUB0N

Note

- Inform the Requesting Party of the SUB code assigned to the Transfer Box. When they want to have a message transferred by your machine, ask them to send the message using SUB code Transmission and specifying this SUB code. If a password has also been programmed, inform them of this too, and ask them to enter it as the SID code.

You can store the following items:

- Box name (required)
Up to 20 characters
- SUB (required)
Up to 20 characters long and can be composed of digits 0-9, "#", "*", and spaces (the first character cannot be a space).

- Password (optional)
Up to 20 characters long and can be composed of digits 0-9, "#", "*", and spaces (the first character cannot be a space).
When registering a password, a mark is displayed in front of the Box name.
- Receiving Station (required)
You can store five receiving stations (destinations to which messages will be forwarded) for each box. Specify receiving stations with Quick Dials or Groups assigned to Quick Dials that have been programmed beforehand.

Limitation

- ❑ After messages are transferred, Transfer Result Reports are not sent back to the sender.

Note

- ❑ After messages are transferred, they are deleted.
- ❑ When this function is turned on, the machine prints out the received messages it transfers and a Transfer Result Report after the transfer has finished. If you want to turn this function off, please contact your service representative.
- ❑ When the programmed receiver is a Multi-step Transfer Group Dial, Multi-step Transfer takes place. For more information, contact your service representative.
- ❑ You can edit boxes in the same way you program them.
- ❑ Deleting a destination specified as an end receiver from the Address Book causes the settings for the end receiver to be deleted. If this is the case, reprogram the end receiver. If the destination has been changed, a message is transmitted to the new destination.

1 Press the [User Tools/Counter] key.

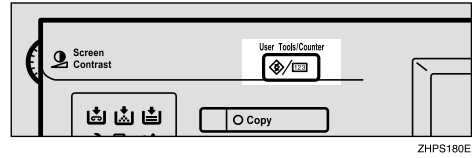

2 Press [Facsimile Features].

3 Select [Key Operator Tools].

4 Select [Box Setting].

5 Select a box to program.

When programming a new box, press [*Not Programed].

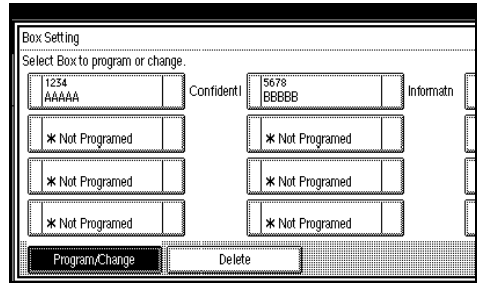

Note

- ❑ To change a box already programmed, press it, and then proceed to step 8.

6 Press [Transfer Box].

7 Enter a Box name, and then press [OK].

Reference

"Entering Text", *General Settings Guide*

8 Enter a SUB code.

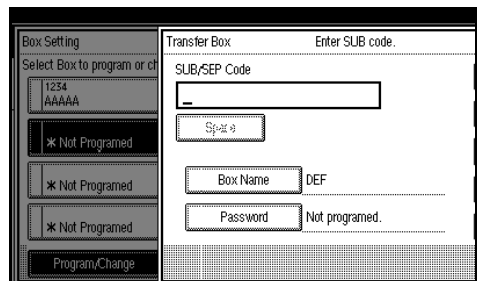

Note

- To change the SUB code, press **[Clear]** or the **[Clear/Stop]** key, and then try again. To change Box name, press **[Box Name]**, and then repeat from step 7.

9 Specify the condition of registration.**Programming receiving stations****1 Select a receiving station.****Note**

- You can store five receiving stations.

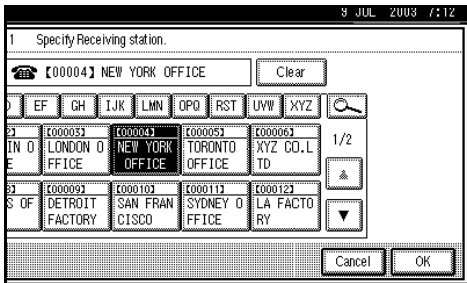
2 Specify receiving stations with Quick Dials, and then press [OK].**Note**

- You can also specify receiving stations with Group Dials.

Repeat from step 1 to specify another receiving station.

Programming a password

If you do not want to program a password, proceed to step 10.

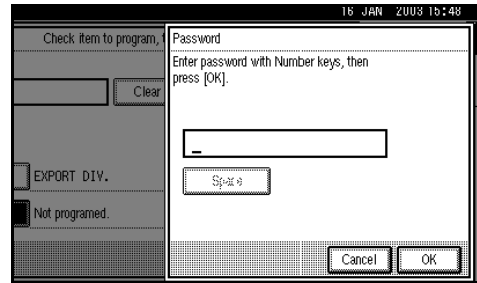
1 Press [Password].**2 Enter a password, and then press [OK].****Note**

- If you make a mistake, press **[Clear]** or the **[Clear/Stop]** key before pressing **[OK]**, and then try again.

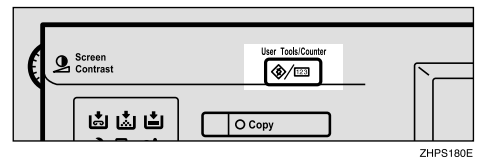
10 Press [OK].**11 Press [Exit].****12 Press the [User Tools/Counter] key. The initial display appears.****Deleting Transfer Boxes****1 Press the [User Tools/Counter] key.****2 Press [Facsimile Features].****3 Select [Key Operator Tools].****4 Select [Box Setting].**

- 5** Press **[Delete]**, and then select the box you want to delete.

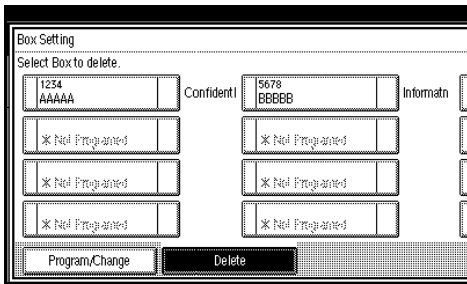

With a programmed password

- 1** Enter a password using the number keys, and then press **[OK]**.

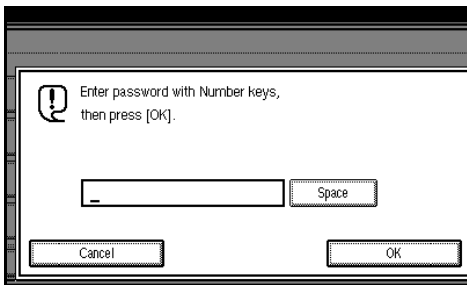

- 6** Press **[Delete]**.

Note

- To cancel deleting a special sender, press **[Do not Delete]**. The display returns to that of step **5**.

- 7** Press **[Exit]**.

- 8** Press the **[User Tools/Counter]** key. The initial display appears.

Printing the box list

Follow the procedure below to print a list showing the currently programmed Personal Boxes, Information Boxes, and Transfer Boxes.

- 1** Press the **[User Tools/Counter]** key.

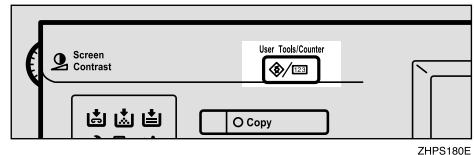

- 2** Press **[Facsimile Features]**.

- 3** Select **[Key Operator Tools]**.

- 4** Press **[Print List]** next to “Box Setting”.

- 5** Press the **[Start]** key.

After printing the list, you can then start from step **4**.

Note

- To cancel printing a list before pressing the **[Start]** key, press **[Cancel]**. The display returns to that of step **4**.
- To cancel printing a list after pressing the **[Start]** key, press **[Stop Printing]**. The display returns to that of step **4**.

- 6** Press the **[User Tools/Counter]** key. The initial display appears.

Transfer Report

For the requesting party to be able to receive Transfer Result Reports from the Transfer Station, the requesting party must program the number of the telephone line in connection on their own machine. See p.48 "Transfer Request".

Be sure to insert a pause after the area code.

For example, if you are in the United States and your fax number is 212-1234567, program the following:

- 1212-1234567

You can program the fax number for the G3 line.

Limitation

- ❑ You cannot program or edit a Transfer Report when using a line (during communication). Program or edit after communication.

Note

- ❑ You cannot use Transfer Request if the telephone number of their machine is not programmed into that machine.
- ❑ Up to 16 digits are available for G3.

1 Press the **[User Tools/Counter]** key.

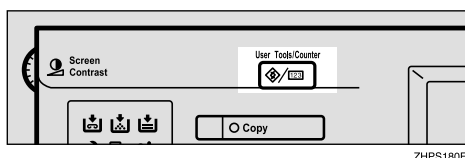

2 Press **[Facsimile Features]**.

3 Select **[Key Operator Tools]**.

4 Select **[Transfer Report]**.

5 Specify the fax number for each line.

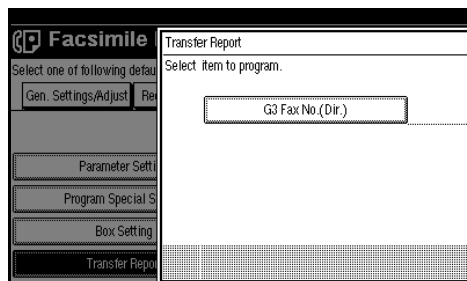

Programming a G3 Fax Number

1 Press **[G3 Fax No.(Dir.)]**.

2 Enter your facsimile number using the number keys, and then press **[OK]**.

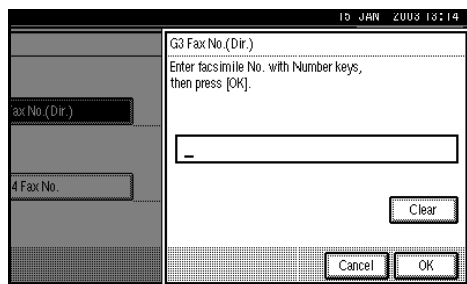

6 Press **[Exit]**.

7 Press the **[User Tools/Counter]** key. The initial display appears.

Programming a Confidential ID

Program a Confidential ID to print a Confidential Reception. See p.32 "Printing a Confidential Message".

Note

- ❑ If you do not program a Confidential ID, you cannot receive a Confidential Transmission.

1 Press the **[User Tools/Counter]** key.

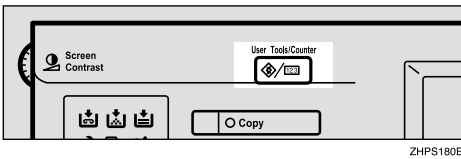

2 Press **[Facsimile Features]**.

3 Select **[Key Operator Tools]**.

4 Select **[Program Confidential ID]**.

5 Enter an ID using the number keys, and then press **[OK]**.

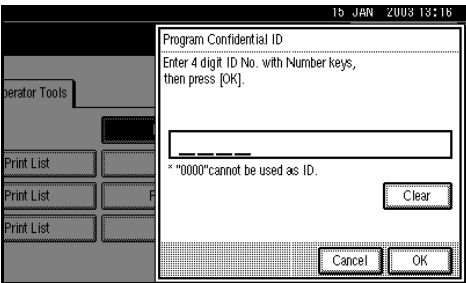

Note

- ❑ A Confidential ID can be any four-digit number, except 0000.
- ❑ If you make a mistake, press **[Clear]** or the **[Clear/Stop]** key before pressing **[OK]**, and then try again.

To cancel programming an ID, press **[Cancel]**. The display returns to that of step **4**.

6 Press the **[User Tools/Counter]** key.

The initial display appears.

Programming a Polling ID

Program a Polling ID to use the Transfer Request, Transfer Station, Default ID Polling Transmission, and Default ID Polling Reception functions. When you use ID Transmission, program the same ID as the one registered on the sender's machine.

Reference

- p.9 "Polling Transmission"
- p.12 "Polling Reception"
- p.69 "Selecting transmission options for a single transmission"
- p.48 "Transfer Request"

1 Press the **[User Tools/Counter]** key.

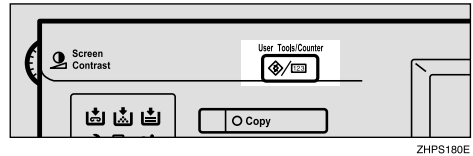

2 Press **[Facsimile Features]**.

3 Select **[Key Operator Tools]**.

4 Select **[Program Polling ID]**.

5 Enter an ID using the number keys and **[A]** to **[F]**, and then press **[OK]**.

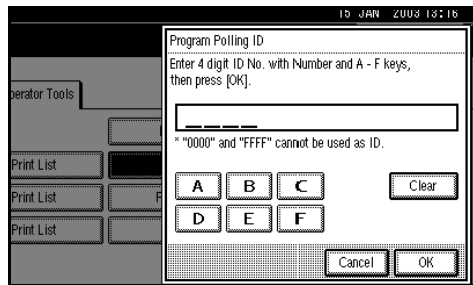

Note

- A Polling ID can be any combination of digits (0-9) and letters (A-F), except 0000 and FFFF.
- If you make a mistake, press **[Clear]** or the **[Clear/Stop]** key before pressing **[OK]**, and then try again.

To cancel programming an ID, press **[Cancel]**. The display returns to that of step **4**.

- 6** Press the **[User Tools/Counter]** key.
The initial display appears.

Programming a Memory Lock ID

Program a Memory Lock ID to be entered before printing documents when the Memory Lock function is activated.

A Memory Lock ID can be any four-digit number, except 0000.

- 1** Press the **[User Tools/Counter]** key.

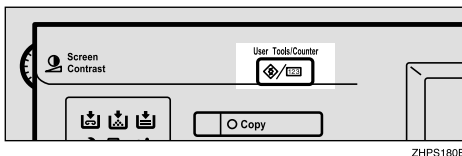

- 2** Press **[Facsimile Features]**.
- 3** Select **[Key Operator Tools]**.
- 4** Select **[Program Memory Lock ID]**.
- 5** Enter an ID using the number keys, and then press **[OK]**.

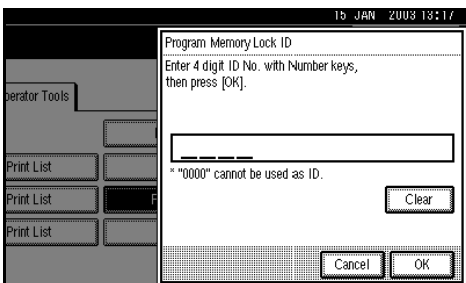
**Note**

- If you make a mistake, press **[Clear]** or the **[Clear/Stop]** key before pressing **[OK]**, and then try again.

To cancel programming an ID, press **[Cancel]**. The display returns to that of step **4**.

- 6** Press the **[User Tools/Counter]** key.
The initial display appears.

Selecting Dial/Push Phone

Use this function to select a line type when the machine is connected to a G3 analog line.

Dial and Push lines are available for selection.

Note

- When the optional G3 expansion unit is installed, "G3-2" and "G3-3" appear.
- This function is not available in some areas.

- 1** Press the **[User Tools/Counter]** key.

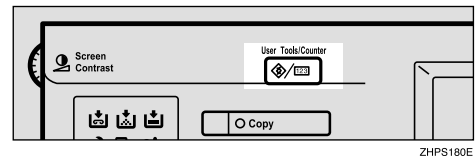

- 2** Press **[Facsimile Features]**.
- 3** Select **[Key Operator Tools]**.
- 4** Select **[Select Dial/Push Phone]**.

- 5** Press **[Push Button Phone]** or **[Dial Phone (10PPS)]** to select the line, and then press **[OK]**.

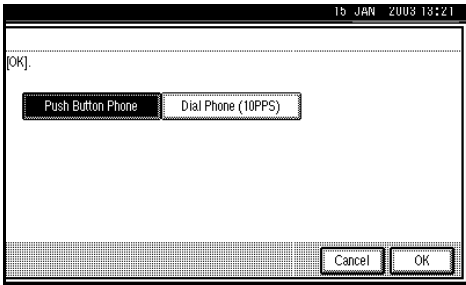

Reference

p.178 “Selecting the Line Type”

- 6** Press the **[User Tools/Counter]** key.
The initial display appears.

Storing or Printing Received Documents

The optional printer/scanner unit or network board is required. When the network board is used, the optional SDRAM 128 MB is also required.

Specify whether received documents are to be saved on the hard disk or printed immediately without being saved. You can print stored documents repeatedly or download them as images to a computer using a Web browser. If you select printing without saving, documents are printed each time they are received.

Limitation

- If using System Settings you have set the machine to distribute received faxes to the delivery server, the documents cannot be saved on the hard disk.

Note

- Documents saved on the hard disk are categorized as received and stored documents. For details about printing saved documents, see p.30 “Printing/Deleting Received and Stored Documents (Printing Stored RX File)”.
- You cannot switch the setting if received documents have been stored on the hard disk. To switch the setting, print or delete documents stored on the hard disk.
- Received confidential messages are stored in memory. Use the Print Confidential RX File function to print them.
- With **[Store]** selected, more memory space will be used as the number of saved documents increase. After memory space becomes insufficient, no more documents are saved on the hard disk. If this happens, the machine will start printing and deleting saved documents with the oldest one.

- 1** Press the **[User Tools/Counter]** key.

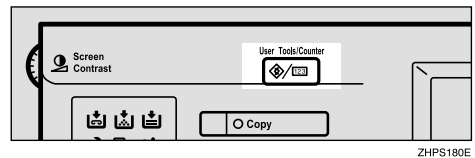

- 2** Press **[Facsimile Features]**.
- 3** Press **[Key Operator Tools]**.
- 4** Press **[Reception File Setting]**.

- 5** Select **[Print]** or **[Store]**, and then press **[OK]**.

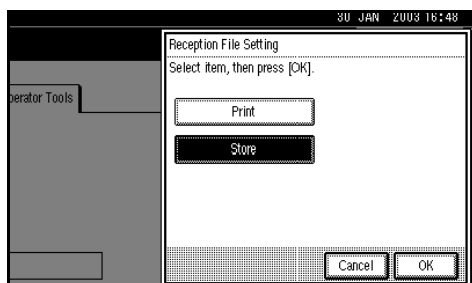

Note

- To cancel your selection, press **[Cancel]**. The display returns to that of step **4**.

- 6** Press the **[User Tools/Counter]** key.
The initial display appears.

Setting a User Code for Viewing Received and Stored Documents

You can view and print documents received and saved on the hard disk using a Web browser. Specify whether or not a user code is entered to view saved documents. If you prefer to use a user code, set one using a maximum of eight digits.

Note

- This function is only available when received documents are saved on the hard disk. See p.172 “Storing or Printing Received Documents”.
- You can set a user code with the System Settings. See the *General Settings Guide*.
- If the programmed user code has been deleted using the Address Book Management function under System Settings, you cannot view received and saved documents using a Web browser. Select **[OFF]** in step **5** or reprogram a user code.

- 1** Press the **[User Tools/Counter]** key.

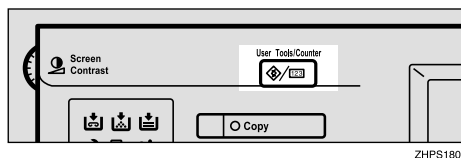

- 2** Press **[Facsimile Features]**.

- 3** Press **[Key Operator Tools]**.

- 4** Press **[Stored RX File User Code Setting]**.

- 5** If you prefer to use a user code, press **[ON]**.

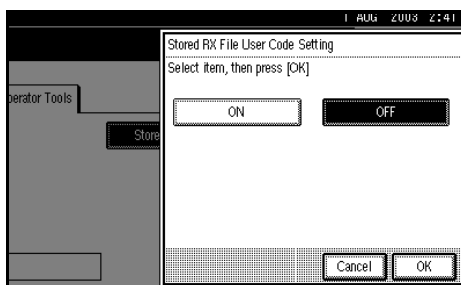

Note

- If you prefer not to use a user code, proceed from step **7**.
- To cancel the selection, press **[Cancel]**. The display returns to that of step **4**.

- 6** Enter a user code (eight digits maximum) using the number keys, and then press **[#]**.

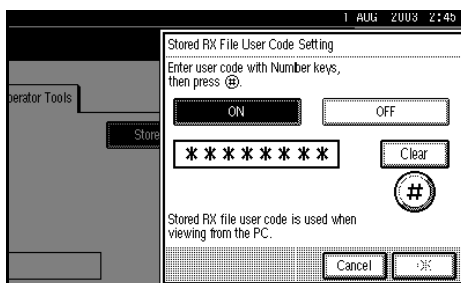

Note

- If you enter a wrong user code, press **[Clear]** or the **[Clear/Stop]** key, and then try again.

7 Press [OK].

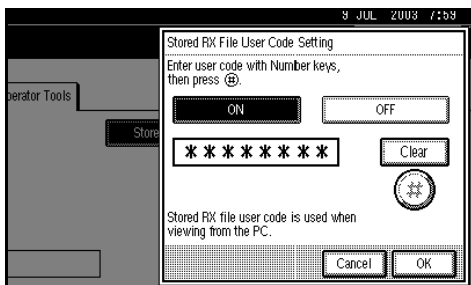

8 Press the **[User Tools/Counter]** key.
The initial display appears.

9

10. Solving Operation Problems

Reading Reports

Error Report

An Error Report is printed if a message cannot be successfully sent or received.

Possible causes include a problem with your machine or noise on the telephone line. If an error occurs during transmission, resend the original. If an error occurs during reception, ask the sender to resend the message.

Note

- If an error happens frequently, contact your service representative.
- The “Page” column gives the total number of pages. The “Page Not Sent” column gives the number of pages not sent or received successfully.

Power Failure Report

CAUTION:

- *When you disconnect the power plug from the wall outlet, always pull the plug (not the cable).*

Even if the main power switch is turned off, the contents of the machine memory (for example, programmed numbers) will not be lost. However, if power is lost for about one hour because the main power switch is turned off, there is a power cut, or the power cable is removed, contents of the Fax memory will be lost. Lost items will include any fax messages stored in memory using Memory Transmission/Reception, Auto Document, Confidential Reception, Memory Lock, or Substitute Reception.

If a file has been deleted from memory, a Power Failure Report is automatically printed as soon as the power is restored. This report can be used to identify lost files. If a memory stored for Memory Transmission was lost, resend it. If a message received by Memory Reception or Substitute Reception was lost, ask the sender to resend it.

 **Important**

- ❑ Do not turn off the main power switch while the power indicator is lit or blinking. If you do, the hard disk and memory may be damaged and failure could result.
- ❑ Turn off the main power switch before pulling out the plug. If you pull out the plug with the switch on, the hard disk and memory may be damaged and failure could result.
- ❑ Make sure that 100% is shown on the display before you unplug the machine. If a lower value is shown, some data is currently present in memory.
- ❑ Right after a power failure, the internal battery needs to be sufficiently recharged to guard against future data loss. Keep the machine plugged in and the main power switch on for about one week after the power loss.

 **RDS (Remote Diagnostic System)**

If your machine has a problem, a service representative can perform various settings over the telephone line from the service station.

If you want to use this function, change the User Parameter. See p.147 “Changing the User Parameters” (switch 25, bit 4).

Replacing the Stamp Cartridge

The optional Auto Document Feeder (ADF) is required.

When the stamp becomes lighter, replace the cartridge.

Note

- Use the cartridge specified for this machine.
- Do not add ink to the cartridge by yourself. Neglecting this can cause ink leakage.

- 1** Lift the ADF, and then open the stamp cover.

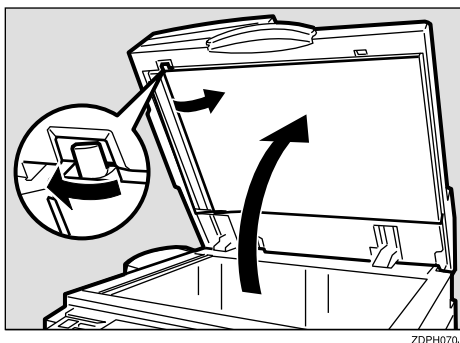

- 2** Pull out the cartridge.

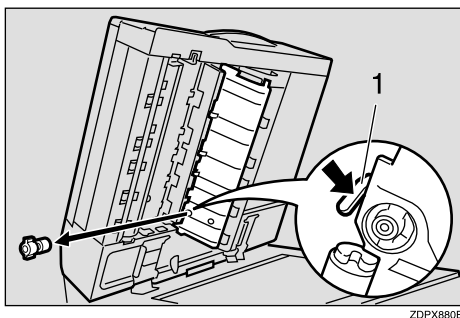

1. Cartridge Lock Lever

- 3** Set a new cartridge.

Insert the cartridge until the metal parts are no longer visible.

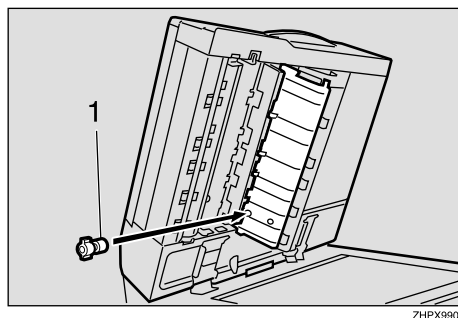

1. New Cartridge

- 4** Replace the stamp cover until it clicks.

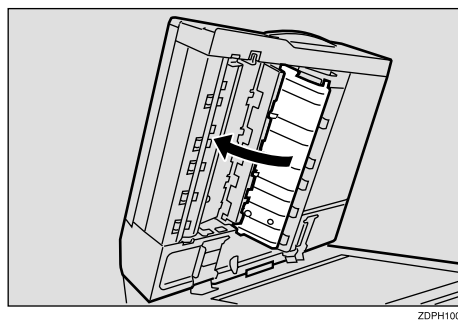

- 5** Lower the ADF.

Connecting the Machine to a Telephone Line and Telephone

Connecting the Telephone Line

To connect the machine to a telephone line, use a snap-in modular type connector.

Important

Make sure the connector is the correct type before you start.

◆ Where to connect the machine

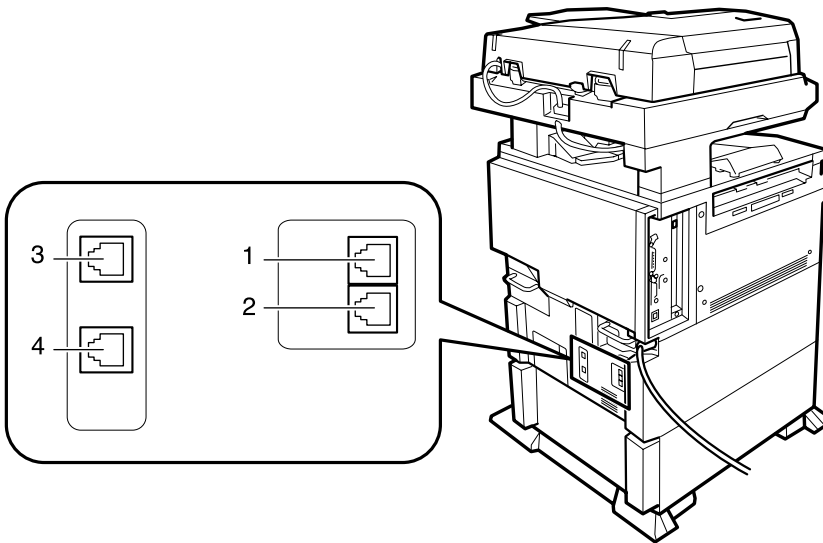

ZHNX550E

1. G3 interface unit connector

2. External telephone connector

3. Extra G3 interface unit connector

4. Extra G3 interface unit connector

Note

A maximum of two G3 lines can be connected.

Selecting the Line Type

Select the line type to which the machine is connected. There are two types: tone and pulse dial.

Note

This function is not available in some areas.

Select the line type using “Key Operator Settings”. See p.171 “Selecting Dial/Push Phone”.

Optional Equipment

Fax Function Upgrade Unit

JBIG compression for transmission/reception becomes possible.

You can increase the maximum programmable numbers of the following functions. See p.184 "Maximum Values".

- Quick Dial
- Memory Transmission file
- Auto Document
- Specific Sender
- Program
- Transmission Result
- Box

Expansion Memory (32MB: DIMM)

This allows you to send and receive fax messages at high resolution (Fine or Super Fine). If you require this option, consult your service representative. See p.184 "Maximum Values".

Extra G3 Interface Unit

This option provides one extra G3 line connection.

A maximum of two G3 interface units can be installed.

Specifications

Standard	G3
Resolution	G3: 8×3.85/mm•200×100 dpi (Standard), 8×7.7/mm•200×200 dpi (Detail), 8×15.4/mm•200×400 dpi (Fine), 16×15.4/mm•400×400 dpi (Super Fine: optional expansion memory required)
Transmission time	G3: 3 seconds at 28,800 bps, Standard resolution
Data compression method	MH, MR, MMR, JBIG (optional fax function upgrade unit required)
Maximum original size	Standard size: A3, 11"×17" Irregular size: 304×432 mm
Maximum scanning size	297×1,200 mm/11"×47"
Print process	Printing on standard paper using a laser
Transmission speed	G3: 33,600/31,200/28,800/26,400/24,000/21,600/19,200/16,800/14,400/12,000/9,600/7,200/4,800/2,400 bps (auto shift down system)









❖ Power Consumption

Standby mode	230 W
Transmission	230 W
Reception	230 W
Maximum power consumption	1,500 W
Low power mode/sleep mode	20 W or less

Acceptable Types of Originals

Make sure your originals are completely dry before setting them in the machine. Wet ink or correcting fluid from originals will mark the exposure glass and affect the resulting image.

Acceptable original sizes

Where original is set	Acceptable original size	Maximum number of sheets	Paper thickness
Exposure glass	Up to A3 (297×420 mm), 11"×17" (279×432 mm)	1	----
ADF, one-sided document	Fax transmission: A5  to A3  (up to 1,200 mm long) 8"×5½"  to 11"×17" 	80 sheets (80 g/m ² , 20 lb)	40-128 g/m ² (11-34 lb)
ADF, two-sided document	Fax transmission: A5  to A3  (up to 432 mm long) 8"×5½"  to 11"×17" 	80 sheets (80 g/m ² , 20 lb)	52-105 g/m ² (14-28 lb)

Paper size and scanned area

◆ Exposure Glass

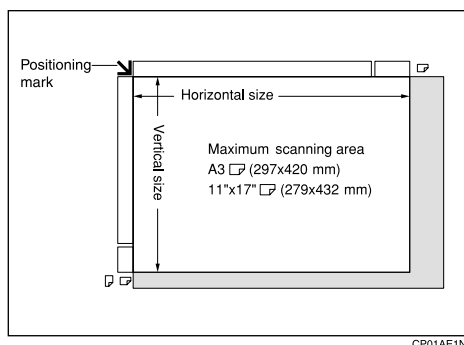

◆ ADF

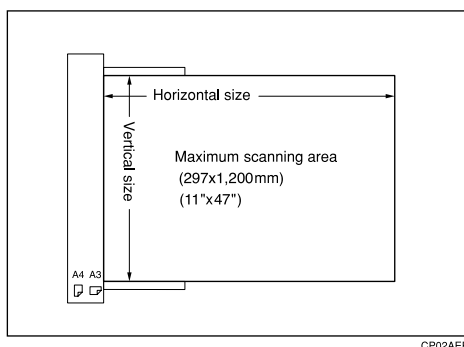

Limitation

- ❑ There may be a difference in the size of the image when it is printed at the destination.
- ❑ If you place an original larger than A3, 11"×17" on the exposure glass, only an A3, 11"×17" area is scanned.

Note

- ❑ Even if an original is correctly placed on the exposure glass or in the ADF, a margin of 3 mm (0.1") around each edge of the original may not be sent.
- ❑ If the receiver uses paper of a smaller width than the original, the image will be reduced to fit that paper. See p.68 "Auto Reduce".
- ❑ The machine detects paper sizes in the following ways:
 - When you place an original in the ADF, an original wider than about 264 mm (10.4") is scanned as A3, 11"×17" size. An original narrower than about 230 mm (9.1") will be sent as 8¹/₂"×11" or 8¹/₂"×14" size. Originals up to 1,200 mm (47.2") in length can be scanned.
 - Refer to the table below for sizes the machine can detect when you place an original on the exposure glass. Because the machine scans non-standard size documents in a standard size, part of the image may be truncated depending on the length of the document. For details about how to set non-standard size documents, see p.14 "Setting a Scan Area", *Facsimile Reference* <Basic Features>.

Metric Version

		Length *1			
		-249 mm	249 mm-274 mm	274 mm-316 mm	316 mm-
Width	-243 mm	×	B5 JIS	A4	F
	243 mm-268 mm	B5 JIS	B4 JIS	B4 JIS	B4 JIS
	268 mm-	A4	A3	A3	A3

Inch Version

		Length *1			
		-9.8"	9.8"-10.8"	10.8"-12.4"	12.4"-
Width	-9.6"	×	×	8 ¹ / ₂ "×11"	F
	9.6"-10.6"	11"×8 ¹ / ₂ "	11"×17"	11"×17"	11"×17"
	10.6"-	11"×8 ¹ / ₂ "	11"×17"	11"×17"	11"×17"

× - Unable to auto detect

*1 Normally a length of about 420 mm (16.5") can be scanned; however, it is only possible to specify a scanning size up to 432 mm (17").

 **Maximum scan area**

The maximum scan area is shown below:

- Memory Transmission: 297×1,200 mm/11"×47" (W×L) from the ADF
- Immediate Transmission: 297×1,200 mm/11"×47" (W×L) from the ADF

 **Note**

- During Immediate Transmission, the length of the scanning range can become narrower than 1,200 mm (47"), depending on the character size as well as the settings on the destination machine.
- 297×432 mm/11"×17" (W×L) (from the exposure glass)

Maximum Values

The following list contains the maximum value for each item.

Note

- The maximum number of pages that can be stored or transmitted may decrease depending on the contents of documents.

Item	Standard	With optional unit		
		Fax function upgrade unit	Expansion memory	Expansion memory + fax function upgrade unit
Memory	4 MB	4 MB	28 MB	28 MB
The number of pages that you can store in memory (Using A4 size Standard <ITU-T #4Chart>)	Approx. 320	Approx. 320	Approx. 2,240	Approx. 2,240
Total number of all files	400	800	400	800
The number of pages per file	1,000	1,000	1,000	1,000
The number of pages for all files	1,000	1,000	3,000	3,000
The number of destinations you can specify for one file	500	500	500	500
The number of destinations you can specify for all files	500	2,000	500	2,000
The number of Quick Dials you can register *1	500	1,200	500	1,200
The number of Group Dials you can register	100	100	100	100
The number of destinations you can register in a group	500	500	500	500
The number of digits for Dials	128	128	128	128
The number of Programs you can register	100	200	100	200
The number of Auto Documents you can register	6	18	6	18

Item	Standard	With optional unit		
		Fax function upgrade unit	Expansion memory	Expansion memory + fax function upgrade unit
The number of Standard Message Stamps you can register	3	3	3	3
The number of transmission records the machine can store	200	1,000 ^{*2}	200	1,000 ^{*2}
The number of stored documents you can specify at one time	1,000	1,000	1,000	1,000
The number of stored documents you can send at one time	30	30	30	30
The number of pages that you can store in the Document Server (Using ITU-T #4Chart)	Approx. 9000	Approx. 9,000	Approx. 9,000	Approx. 9,000
The number of pages you can store in the Document Server for one document	1,000	1,000	1,000	1,000

^{*1} With the optional printer/scanner unit or network board, a maximum of 2000 destinations can be registered.

^{*2} This indicates the number of transmission records that you can check using SmartNetMonitor for Admin. From the machine you can check up to 400 communication records (transmission plus reception).

INDEX

180-Degree Rotation Printing, 86
2-Sided Printing, 77

A

Acceptable Types of Originals, 181
Address Book, 104
Attaching a cover sheet, 101
Authorized Reception, 153
Auto Document, 59, 138
 Changing, 138
 Deleting, 140
 Sending, 59
 Storing, 138
Auto Fax Reception Power-up, 83
Automatic Redial, 72
Auto Reduce, 68

B

Basic Transmission, 99
Batch Transmission, 72
Book Fax, 55
Box Setting, 136, 160
Broadcasting Sequence, 73

C

Canceling
 Transmission, 16
 Transmission Files, 15
Center Mark, 84
Chain Dial, 43
Changing
 Line Type, 53
 Transmission Time, 19
Checkered Mark, 84
Checking
 Reception Result (RX File Status), 28
 Transmission Files, 15
 Transmission Result (TX File Status), 27
Combine 2 originals, 77
Combine Two originals, 87
Communication Failure Report, 75
Communication Information, 23
Confidential File Report, 33
Confidential ID, 170
Confidential Message, 32
Confidential Transmission, 7
Counters, 135, 142

D

Default ID/Free Polling Reception, 12
Default ID Transmission, 9, 10, 69
Deleting
 Information Box Messages, 41
 programmed destinations, 104
Destination
 Adding, 18
 Checking, 15
 Deleting, 17
Displaying the Memory Status, 29
Document Server, 117
 Delete File, 122
 File Manage, 120
 Storing a Document, 118
Dual Access, 73

E

ECM (Error Correction Mode), 72, 135, 146
Economy Transmission Time, 3
Editing programmed destinations, 104
End Receiver, 48, 81
end receiver, 144
Error Report, 175
Expansion Memory, 179
Extra G3 Interface Unit, 179

F

Fax Function Upgrade Unit, 179
Fax Header Print, 67
File
 Printing, 20
 Printing a List of Files in Memory
 (*Print TX File List*), 22
 Resending, 21
Forwarding, 135, 143, 154
Free Polling Transmission, 9, 10
Full/Partial agreement, 152

G

General Settings/Adjustment, 130

H

Handy Dialing Functions, 43

I

ID Override Polling Reception, 12
ID Override Transmission, 9
Image Rotation, 73, 87
Immediate Reception, 77
Information Boxes, 38, 163, 164
 Deleting, 164
 Printing, 168
 Programming/Editing, 163
 Storing Messages, 38

J

JBIG, 74, 82
 Reception, 82
 Transmission, 74
Journal, 23
"Just Size" Printing, 90

K

Key Operator Code, 128
Key Operator Settings, 135
Key Operator Tools List, 135
Keystroke Program, 113

L

Label Insertion, 68
LAN-Fax Features, 95
LAN-Fax Operation Messages, 107
LAN-Fax Properties, Setting, 98
Line Type, 53, 178

M

Manual Dial, 52
Maximum Value, 184
Memory Lock, 34, 145, 154
Memory Lock ID, 171
Memory Reception, 77
Memory Status, 29
Memory Storage Report, 75
More Transmission Functions, 71
Multi-copy, 77
Multi-copy Reception, 86
Multi-port, 53
Multistep Transfer, 81

O

On Hook Dial, 51
Optional Equipment, 179
Originals, 181
Output Tray, 93

P

Page Reduction, 89
Page Separation and Length Reduction, 88
Paper Tray, 132
Parallel Memory Transmission, 71
Parameter Setting, 135
Personal Boxes, 36, 161, 162
 Deleting, 162
 editing, 161
 Printing, 168
 Programming, 161
Polling ID, 170
Polling Reception, 12
Polling Reserve Report, 13
Polling Result Report, 13
Polling Transmission, 9
Polling Transmission Clear Report, 11
Power Failure Report, 175
Print 2 Sided, 154
Print Completion Beep, 84
Printed Report, 75
Printing
 Box List, 168
 Confidential Message, 32
 File Received with Memory Lock, 34
 Information Box Messages, 40
 Journal, 23
 Options, 84
 Personal Box Messages, 36
 Special Sender List, 160
Printing or Saving as Files, 103
Printing the Journal, 23
Programming new destinations, 104
Programs, 113
 Changing, 113
 Deleting, 116
 Registering, 113
PWD Code, 47

R

- RDS (Remote Diagnostic System), 176
- Reception, 77
 - Reception Features*, 77
 - Reception File Print Quantity*, 154
 - Reception Functions*, 81
 - Reception Reverse Printing*, 154
 - Reception Setting*, 132
 - Reception Time*, 85
- Redial, 43
- Reduced Image Transmission, 68
- Report, 75, 175
 - Communication Failure Report*, 75
 - Error Report*, 175
 - Memory Storage Report*, 75
 - Power Failure Report*, 175
 - Transmission Result Report (Immediate Transmission)*, 76
 - Transmission Result Report (Memory Transmission)*, 75
- Requesting Party, 48, 81
- Reverse Order Printing, 77, 88
- RX File Status, 28

S

- Scan Size, 140
 - Changing*, 140
 - Deleting*, 142
 - Programming*, 140
- Selecting
 - Dial/Push Phone*, 171
 - Line Type*, 178
- Sender Stamp, 68
- Sending at a Specific Time (Send Later), 3
- Send Later, 3
- SEP Code, 46
- Setting Priority Trays, 91
- SID Code, 46
- Simultaneous Broadcast, 73
- Solving Operation Problems, 175
- Special Senders, 152
- Special Senders to Treat Differently, 152
- Specifications, 180
- Specifying options, 101
- Specifying Tray for Lines, 93
- Stamp, 66
- Stamp Cartridge, 177
- Standard Messages, 137
 - Deleting*, 138
 - Programming*, 137

- Standard Message Stamp, 58
- SUB Code, 45
- Substitute Reception, 79
- Switches and Bits, 147

T

- Telephone Line, 178
- Transfer Boxes, 165, 167
 - Deleting*, 167
 - Printing*, 168
- Transfer Report, 169
- Transfer Request, 48
- Transfer Result Report, 82
- Transfer Station, 48, 81
- Transmission Features, 43
- Transmission Mode, 3
- Transmission Options, 67
- Transmission Result Report (Immediate Transmission), 76
- Transmission Result Report (Memory Transmission), 75
- Transmission with Image Rotation, 73
- Tray Shift, 93
- TSI Print, 89
- Two-Sided Printing, 85
- Two-Sided Transmission, 56
- TX File, 15
- TX File Status, 27

U

- User Parameter List, 148
- User Parameters, 147

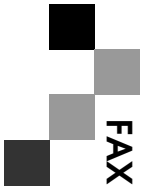

FAX Option Type 2045 Operating Instructions Facsimile Reference <Advanced Fee-